

OCTAVE

V 80 SE

Owner's Manual

English

INTRODUCTION

Congratulations and thank you for choosing OCTAVE

V 80 SE

You are now the owner of one of the world's most innovative and reliable amplifiers. Look after it, and it will provide you many years of listening pleasure.

You often hear people claim that tube amplifier design has not progressed for years. The operating principles of tubes have indeed been documented extensively and are well known to amplifier designers. The same can, of course, be said for transistor amplifiers.

However, advances in both technologies are still possible thanks to the development of innovative and improved components, our greater appreciation of the fundamental principles and, of course, deeper and more advanced insights into the interaction of amplifier and loudspeaker. With tube amplifiers in particular, a general reluctance to depart from the classic circuit designs has not done the technology any favours. Although today's loudspeakers and source equipment provide better performance than ever before, they also make greater demands on amplifiers. Modern sound reproduction equipment delivers a level of performance at a price that simply would not have been possible 20 or even 10 years ago.

These advances have been achieved through the application of latest technological developments as they become available and affordable. We have specialized in tube amplification for the past 30 years, during which time we have developed a number of innovative technologies that have earned us a reputation as one of the leaders in the field.

Here's wishing you many happy hours of musical pleasure!



Andreas Hofmann

CONTENTS

	Page
Introduction.....	3
1. Description of the V 80 SE	7
2. Safety instructions	
2.1. Before you begin	9
2.2. Placement.....	10
2.3. Warranty.....	10
3. Getting started	
3.1. Unpack and check the contents of the box	11
3.2. Removing the grille.....	11
3.3. Installing the power tubes.....	12
3.4. Switching on for the first time - the soft-start feature	13
3.5. Checking the power tubes – setting the bias	14
3.6. Connecting other components to the V 80 SE.....	14
3.7. Connection options: overview	15
4. Controls – the front panel.....	16
5. Connections – the rear panel	18
6. Recommended settings	
6.1. Phono MC or optional MM	20
6.2. Line playback such as CD1, (CD2, AUX, Tuner)	21
6.3. Tape playback and record.....	22
6.4. Front Channel replay (multichannel).....	23
7. Advanced functions and connection options	
7.1. Linear mode	24
7.2. "Extern"-function: Separating the pre- and power amplifier	24
7.2.1. Inserting an external equalizer	25
7.2.2. Using the V 80 SE as a 2-channel power amplifier with an external preamplifier.....	25
7.2.3. Using the V 80 SE in bi-amped systems – application 1 The V 80 SE as an independently adjustable power amplifier	25
7.3. Adjustable preamplifier output, Pre-out	26
7.3.1. Using with a subwoofer.....	26
7.3.2. Using the V 80 SE in bi-amped systems - application 2 The V 80 SE as a central control unit	26
7.4. Ecomode: soft-start and reduced power consumption mode.....	27
7.5. Headphone/speaker operation	28
7.6. Power Selector, alternative output tubes	29

CONTENTS

	Page
8. Tubes	
8.1. Tube layout	30
8.2. Bias measurement system	31
8.3. Replacing the tubes	33
8.4. Running in the tubes	33
8.5. Tube service life.....	33
9. Protection system	34
10. Remote control.....	35
11. Optional Phono - MC/MM	35
12. Option (Super) Black Box	
12.1. The Black Box option	36
12.2. Connecting to the amplifier	36
12.3. The Super Black Box option	37
12.4. Technical Data	37
12.4.1. Black Box	37
12.4.2. Super Black Box	37
13. Troubleshooting	
13.1. Faults caused by external issues.....	38
13.1.1. Buzzing and hum in the speakers.....	38
13.1.2. Mains interference	39
13.1.3. Channels are not balanced.....	39
13.2. Faults caused by tubes, faulty tubes	40
13.2.1. Mechanical tube faults that does not trip the V 80 SE's protection	40
13.2.2. Tube faults that trip the protection system.....	41
14. Technical data	
14.1. In- and outputs	42
14.2. Dimensions	43
14.3. Diagrams.....	44
15. Frequently Asked Questions (FAQ).....	46

1. DESCRIPTION OF THE V 80 SE

The V 80 SE is a totally new design. It has been developed for music lovers who do not have the space for large pre- and power amps. The V 80 SE is guaranteed to provide the same sonic experience as separates. Nevertheless, as a standalone unit, it is equipped with every feature you could need no matter how your hi-fi system is configured. We have also included a number of forward-thinking features that are unique in this amplifier class.

POWER AMPLIFIER + BIAS

The power amplifier is a push-pull pentode system producing up to 130 W RMS each channel from 20 Hz to 80 kHz. The amplifier was designed specifically for the V 80 SE, although its concept borrows heavily from the MRE 220. This power amplifier enjoys **excellent load stability**, i.e. neither the impedance nor the efficiency of the partnering loudspeakers will affect the V 80 SE's sound.

The enhanced display functions of the **bias measurement facility** enable the owner to correctly set the bias current for the wide range of output tubes that are compatible with the V 80 SE. Bias adjustment is carried out using 3-turn precision regulators in conjunction with LEDs for each of the four output tubes.

POWER MANAGEMENT

The high voltage systems and the heaters for the power and preamp tubes form part of a logic-control chain. The power management system also controls the electronic protection and power saving functionality (Ecomode). **The electronic protection continuously monitors the current through the power tubes and the operating voltage of the driver stage.** This protects the unit from any overload situation including power line surges (for example: speaker short circuit, faulty power tube, lightning strike on the power line). The main purpose of the protection system is to prevent damage to the amplifier; its secondary purpose is to protect the power tubes from the harmful long-term effects of overload. At the same time, it enhances user safety by preventing the occurrence of critical conditions that could be harmful to the user.

DOUBLE SAFETY + LONG SERVICE LIFE

Like other OCTAVE products, this amplifier is equipped with a double safety system. This means that, if a component should fail and trigger the electronic protection, a second, higher-level safety feature will always be present. This technology has proven invaluable in recent years. **It has enabled us to reduce our overall failure rate (excepting output tubes, which we are unable to control 100 percent) to virtually zero. OCTAVE equipment is designed for achieve a service life of 10 to 15 years without needing to be serviced.** This is particularly important feature for a tube-based amplifier, as many preconceptions still exist with regard to the technology's durability and long-term stability.

1. DESCRIPTION OF THE V 80 SE

POWER CONSUMPTION Power consumption: The power supply is constructed using a high performance, magnetically shielded transformer employing the lowest loss material currently available. Internal stabilization is designed for maximum efficiency with the lowest possible losses. As a result, no-load power consumption is approximately 180 W. ***The stabilization ensures trouble-free operation of the power supply section between 210 to 250 V (or +/-10 % Mains voltage tolerance). Within this range, the power amplifier's operating point is stable.***

+
ECOMODE The **Ecomode function** monitors the operational status of the V 80 SE and automatically powers it down during extended breaks. This reduces power consumption to less than **30 W compared with 180 W during normal operation** and improves passive safety. When it detects a signal, the V 80 SE activates automatically and is ready for use again within approximately 60 seconds.

FEATURES

- Adjustable pre-out for subwoofer, etc.
- Pre and power amp can be used independently
- Input for multichannel receiver, volume control bypass function
- Tape playback and record; input and output monitor switching
- True XLR input for balanced CD player
- Optional phono MC or MM input
- Separate headphone amplifier; speakers and headphones electronically switchable
- Ecomode: option of monitoring operational status to:
reduce power consumption to **30 W** at no load
- Conveniently accessible true power switch
- Bias measurement facility

2. SAFETY INSTRUCTIONS

2.1. Before you begin

In case of emergency: disconnect the plug from the mains supply

Never use an amplifier that is damaged or faulty. Make sure it has been labeled as defective and that it cannot be used until it has been repaired by a qualified service engineer. Make sure that there is easy access to the IEC socket and power cable.

Do not open the case



There are dangerously high voltages and hot tubes inside this equipment. To avoid a burn or the risk of electric shock, never allow anyone except qualified personnel to open the case or remove the grille.

Service and maintenance

For reasons of safety, please ensure that servicing, repairs and other modifications to OCTAVE equipment are carried out only by a qualified technician. Defective fuses should also only be replaced by a qualified technician. Always replace fuses with ones of the same type and rating. If your amplifier requires servicing, please ship or take your equipment directly to OCTAVE or to one of our authorized service centers.

Symbols used in these instructions

	<p>Caution! Text passages marked with this symbol contain important information which must be observed if the machine is to operate safely and without problems</p>
	<p>This symbol marks text passages which provide supplementary notes and background information; they are intended to help the user understand how to get the best out of the machine</p>

Before connecting

Make sure that the voltage of your amplifier matches your local supply voltage.

Grounding

This amplifier is a protection class 2 device (without an earth conductor), while the power supply is class 1. As a result, a three-pin power cable with a protective ground contact must be used (included in the scope of delivery).

2. SAFETY INSTRUCTIONS

2.2. Placement

Location

- OCTAVE equipment is designed strictly for use in a dry domestic environment. Do not use it in open air or in damp environments!
- Never place plants or liquid-filled containers on your amplifier. Take care that objects do not fall or liquids are not spilled into the enclosure. Should this happen, disconnect the mains plug immediately and have your amplifier checked by a qualified service technician.
- Condensation may form if the amplifier is taken from a cold environment into a warm one. In this case, wait until the amplifier has reached room temperature and is dry before switching it on.
- Avoid installing the amplifier close to sources of heat, such as heaters, or anywhere that it may be in direct sunlight.
- Do not operate your OCTAVE amplifier near flammable materials, gases, or vapors. Avoid areas where there may be heavy accumulations of dust or where the amplifier may be subject to mechanical vibration.
- Place your OCTAVE amplifier on a stable, even surface.

Cover



Never operate the amplifier without the cover

Ventilation

- Ensure sufficient air circulation around your amplifier. If you intend to install your equipment in a cupboard or a shelf unit, ensure that there is at least a 10 centimeter gap between the ventilation slots and the walls all around the amplifier.
- To prevent heat accumulation, the back of the cupboard should have ventilation holes.
- Do not rest the equipment on a soft surface such as carpet or foam sheeting.

2.3. Warranty

OCTAVE can only guarantee the safety, reliability and performance of this unit if modifications and repairs are carried out by specialized personnel and if the amplifier is operated in accordance with the instructions contained in this manual.

3. GETTING STARTED

3.1. Unpack and check the contents of the box

Scope of delivery

- V 80 SE
- 1 set power tubes with tube layout diagram
- Power cord (3-core cable with 3-pin plug)
- Remote control
- 2 screwdrivers:
1 x 3 mm flat-bladed screwdriver for adjusting the bias
1 x 2 mm Allen key for removing the cover
- Owner's manual with certificate

3.2. Removing the grille

In order to be able to insert the tubes, the cover grille must first be removed.



Please note:
Operation without a protective grille is not permitted

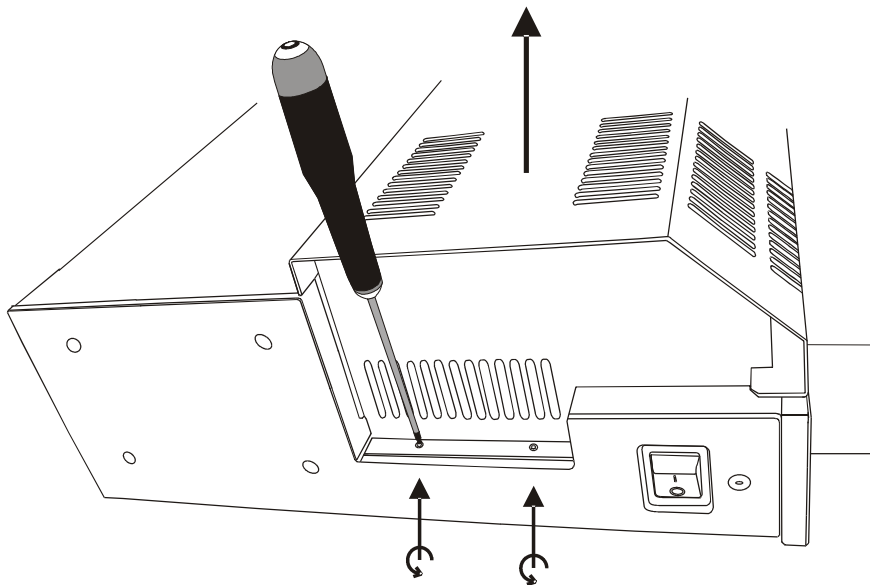

Procedure

1.  For your own safety, make sure that the amplifier is not connected to a wall outlet
2. Completely remove the four hexagonal screws using the Allan key supplied. There are two screws on each side
3. Carefully pull the grille upward to remove

3. GETTING STARTED

3.3. Installing the power tubes

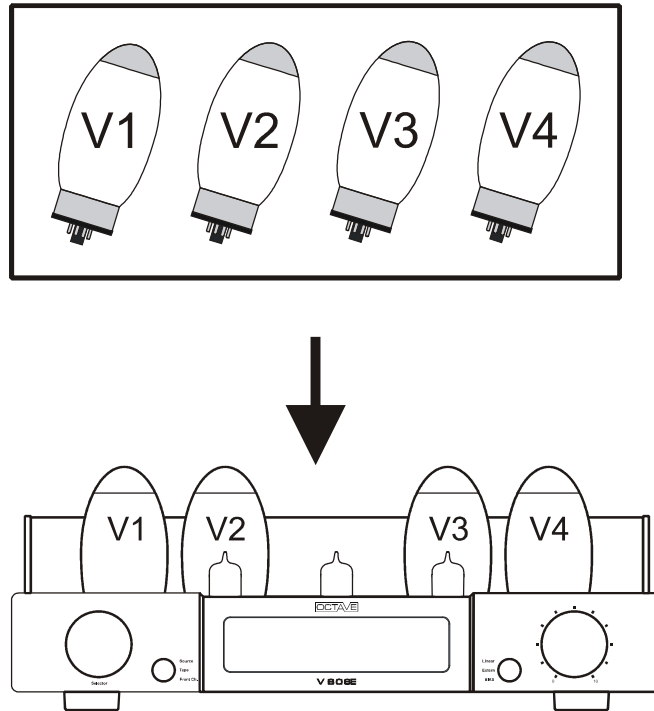

Insert the power tubes into their sockets as shown on the tube layout. Ensure that you correctly locate the anti-rotation lug on each of the tubes.

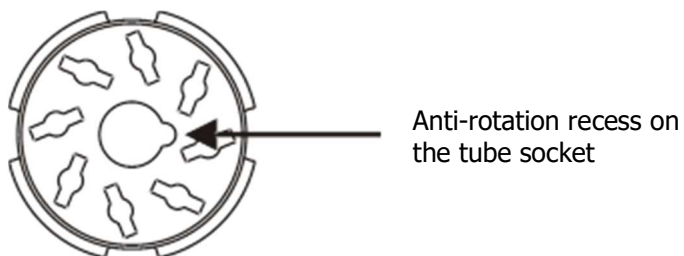

Reinstall the cover grille. (Reverse order of 3.2.)

3. GETTING STARTED

3.4. Switching on for the first time – the soft-start feature

Check that the headphone and Ecomode switches are in the "off" position and plug your amplifier in. (On new units, both of these switches are set to "off" at the factory).

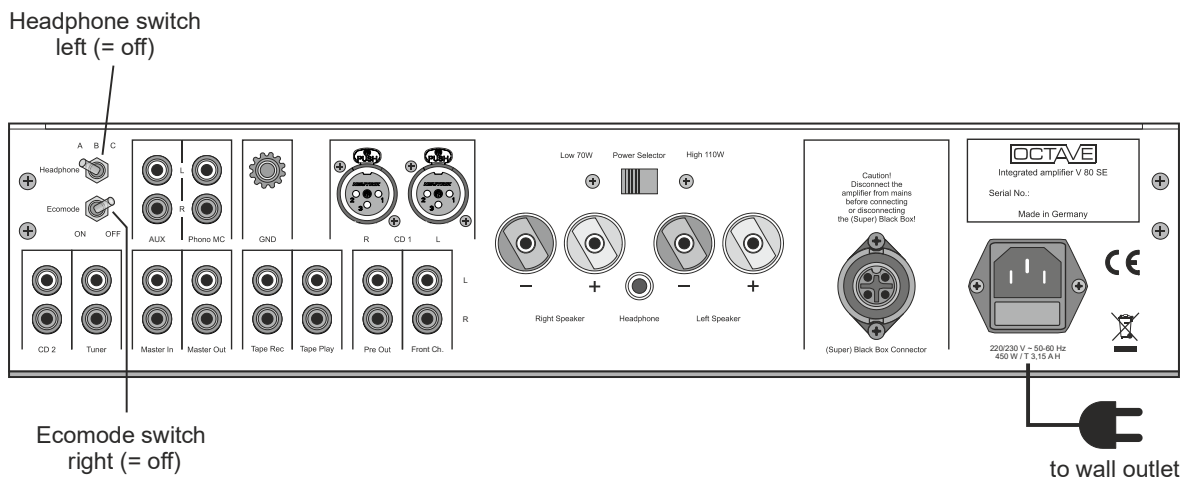

Now switch the V 80 SE on using the amplifier's power on/off switch. 2 or 4 LEDs will illuminate, depending on the position of the switch. The soft-start LED will illuminate.

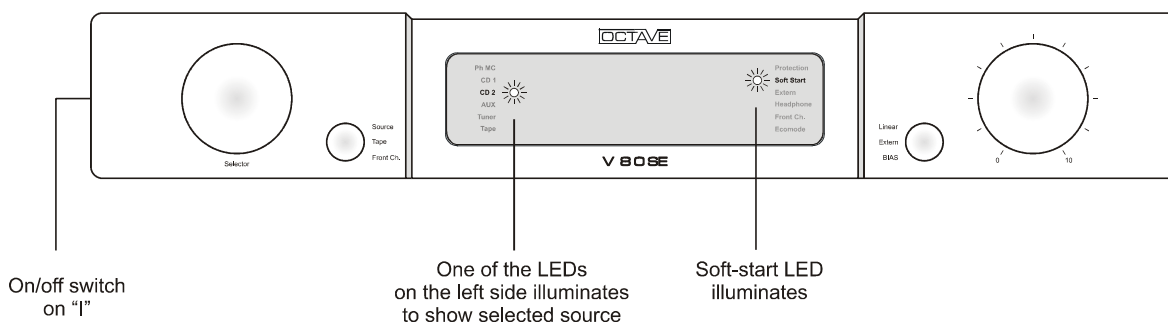

The soft-start LED will remain lit until the unit has powered up. It will extinguish about 20 – 30 seconds later, at which point the amplifier is ready for use.

3. GETTING STARTED

3.5. Checking the power tubes – setting the bias

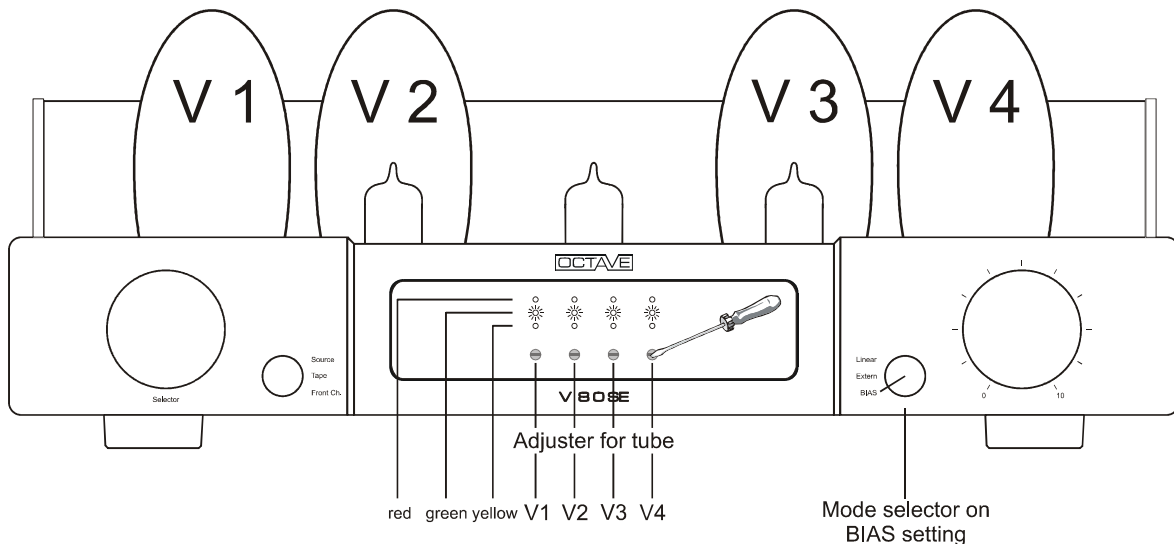

You do not need to have the speakers or any other partnering equipment to be connected to set the bias. (For a more detailed explanation, see chapter 8.3).

Procedure

Turn the mode selector knob to BIAS. Four LEDs will now illuminate in the centre of the display, one for each power tube. If the amplifier is still cold, the LEDs will initially illuminate "yellow". After about five minutes, the tubes will heat up and the LEDs will then show a

1. reading. LED array:

Top row:	red LEDs	Setting is too high
Centre row:	green LEDs	Setting is OK
Bottom row:	yellow LEDs	Setting is too low
2. If the LEDs do not turned green after approximately five minutes, you can now use the small screwdriver supplied to adjust them to "green". (Turn clockwise to increase the current). When all four LEDs are "green", move the mode selector knob to the "Linear" setting if you wish to listen to your system. (Or move the knob to "External" if you wish to connect an equalizer).
3. wish to listen to your system. (Or move the knob to "External" if you wish to connect an equalizer).

3.6. Connecting other components to the V 80 SE

Procedure

1.  Be sure to switch the V 80 SE off again!
2. Connect the other components in your system to the appropriate sockets on the rear of the V 80 SE. (See Chapter 5 "Rear panel connections" and Chapter 6 "Recommended settings". See also Chapter 3.7 "Connection options: overview").
3. Check that the switch positions on the front and rear of the amplifier are in their recommended settings.
4. Switch the V 80 SE on using the on/off switch and wait until the soft-start LED extinguishes. You can now play some music

3. GETTING STARTED

3.7. Connection options: overview

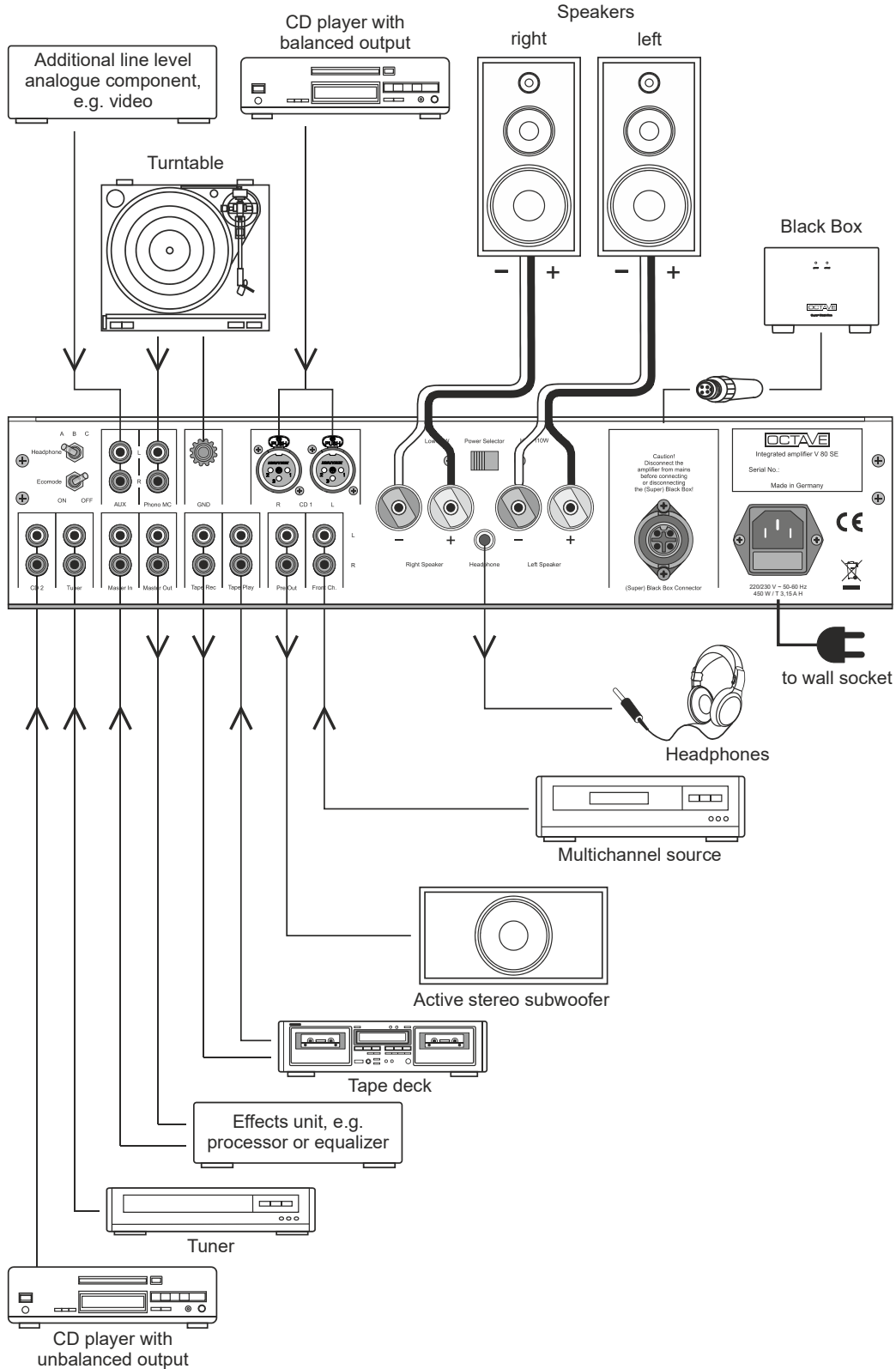

4. CONTROLS – THE FRONT PANEL

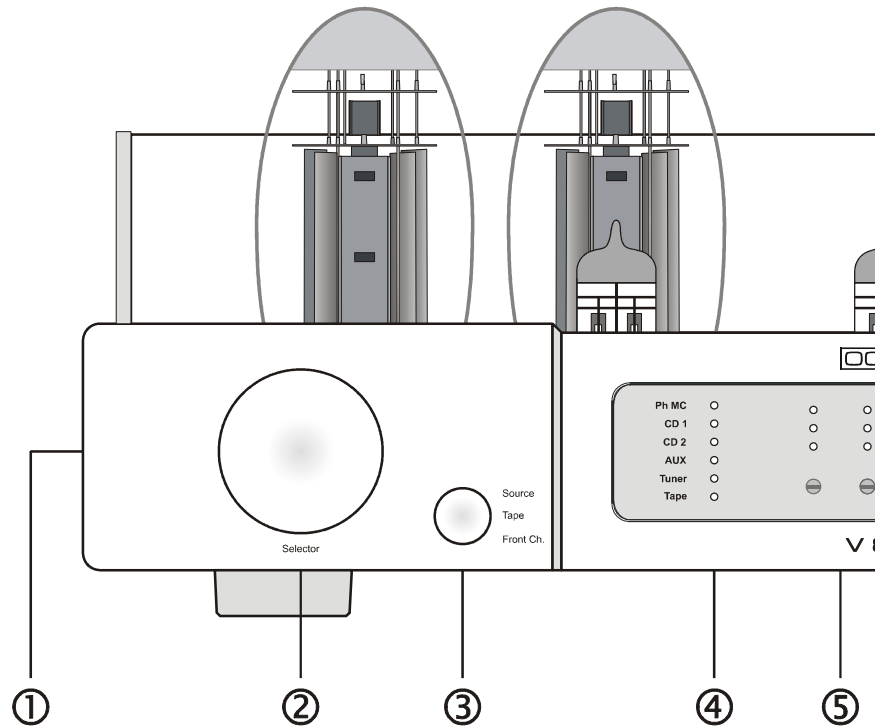

Legend

① Power switch	0 = off; 1 = on. Soft-start LED illuminates during start-up period
② Input selector	This is used to select the desired input signal. A green LED illuminates in the window to show which input you have selected.
	Phono Line level or phono input (if phono has been selected as an option)
	CD1 XLR line level input for CD, SACD and similar
	CD2 RCA line level input for CD, SACD and similar
	Aux RCA line level input for video, etc.
	Tuner RCA line level input for tuner, etc. (Recommended settings, see chapter 6)
③ Secondary input selector	Source Playback of inputs selected with ②
	Tape Playback of Tape or Tape/Monitor, when a recording is being made of the source selected with ② (see chapter 6.3).
	Front Ch. Multi Channel bypass mode. Tape and inputs selected with ② are switched off. In this mode, the V 80 SE functions as a two channel power amplifier. The volume control is bypassed (see chapter 6.4).
④ LED indicators	For switch ② and switch ③
⑤ Bias adjustment	Bias adjustment and LED display for the power tubes (see chapter 8.3).

4. CONTROLS – THE FRONT PANEL

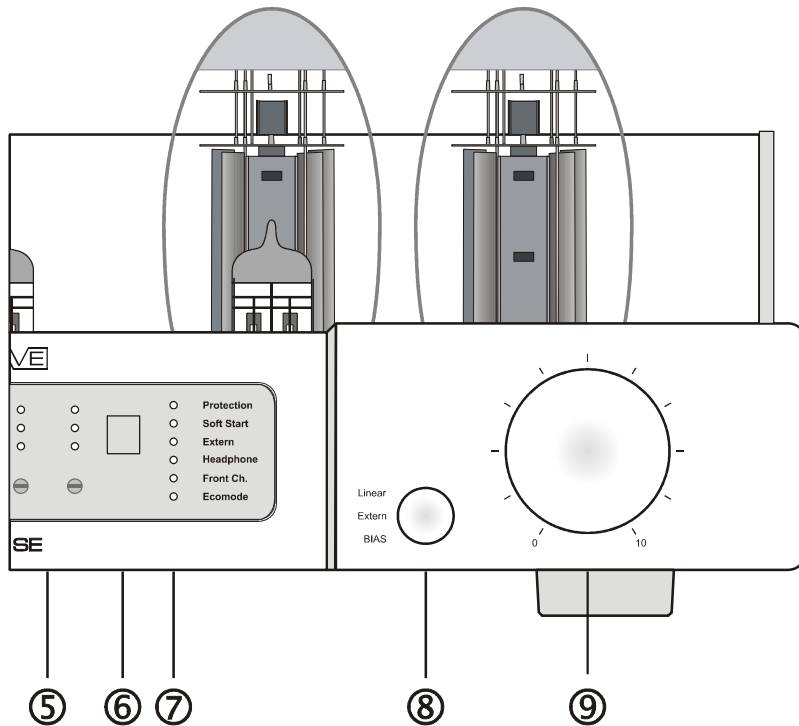

Legend

⑥	Remote control receiver	To ensure optimum operation of the IR remote control, do not cover this window.
⑦	Status indicators	<p>Protection Red LED lights up when the electronic protection system has switched the amplifier off in response to an amplifier fault (see chapter 9).</p> <p>Soft-start Lights up during the soft-start process immediately after switch-on. This LED goes out after about 20 – 30 seconds when soft-start has been completed (see chapter 3.4 + chapter 7.4).</p> <p>Extern Illuminates to indicate separate pre and power amplifier operation (see chapter 7.2).</p> <p>Headphone Illuminates when headphones are connected (see chapter 7.5).</p> <p>Front Ch. Illuminates when multichannel-bypass function is on (see chapter 6.4).</p> <p>Ecomode Illuminates when Ecomode/power saver mode is on (see chapter 7.4).</p>
⑧	Mode selector knob	<p>Linear Pre and power amplifier are connected internally (see chapter 7.1).</p> <p>Extern Pre and power amplifier are separate (see chapter 7.2).</p> <p>BIAS The electronic bias measurement system is on and the LED array shows the power tubes' idle current (see chapter 8.3).</p>
⑨	Volume control	Remote controlled motorized potentiometer.

5. CONNECTIONS – THE REAR PANEL

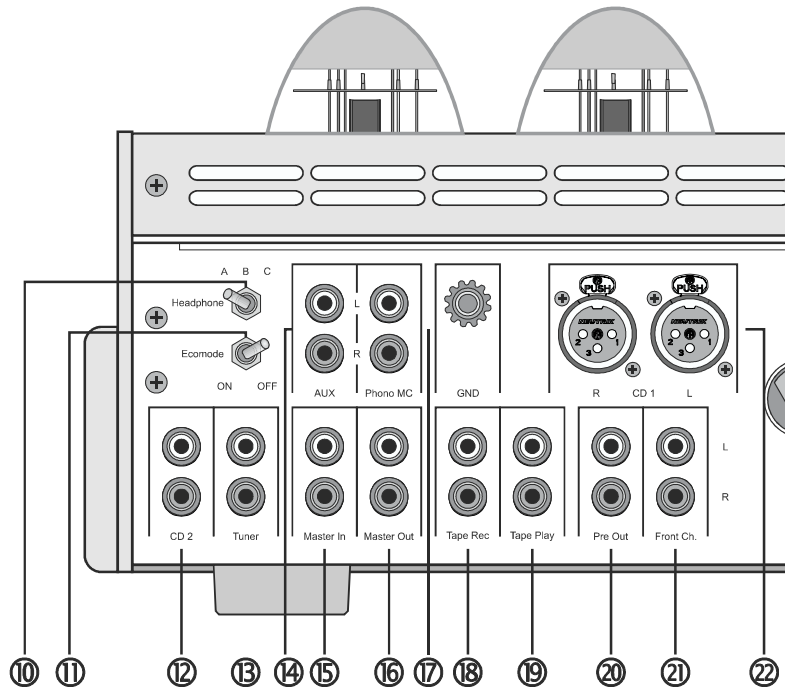

Legend

⑩ **Headphone**



A: Switch left: speaker playback
 B: Switch centre: speaker and headphone playback
 C: Switch right: headphone playback, tube power amplifier is switched off (see chapter 7.5).

⑪ **Ecomode**

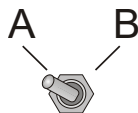

A: Switch left: Ecomode switched on
 B: Switch off: Ecomode off (see chapter 7.4).

⑫ **CD 2**

CD line level input, RCA phono (see chapter 6.2).

⑬ **Tuner**

Tuner line level input, RCA phono (see chapter 6.2).

⑭ **AUX**

Additional RCA line level input for Video, etc. (see chapter 6.2).

⑮ **Master In**

Power amp input when "Extern" function is on (see chapter 7.2).

⑯ **Master Out**

Preamp output when "Extern" function is on (see chapter 7.2).

⑰ **Phono**

RCA line level input, or with phono option: MM/MC input with GND connector for the ground cable of the turntable (see chapters 6.1 and 11).

⑱ **Tape Rec**

Recording output for tape or DAT (see chapter 6.3).

⑲ **Tape Play**

Playback input for tape or DAT (see chapter 6.3).

⑳ **Pre Out**

Adjustable preamp out for subwoofer, etc.
 This output has no muting option (see chapter 7.3).

㉑ **Front Channel**

Input for front R + L front channels of a multichannel receiver/Processor (see chapter 6.4).

㉒ **CD 1**

CD line level input, XLR (see chapter 6.2).

For the inputs, the left channel is white (upper row of sockets) and the right channel is red (lower row of sockets).

5. CONNECTIONS – THE RAER PANEL

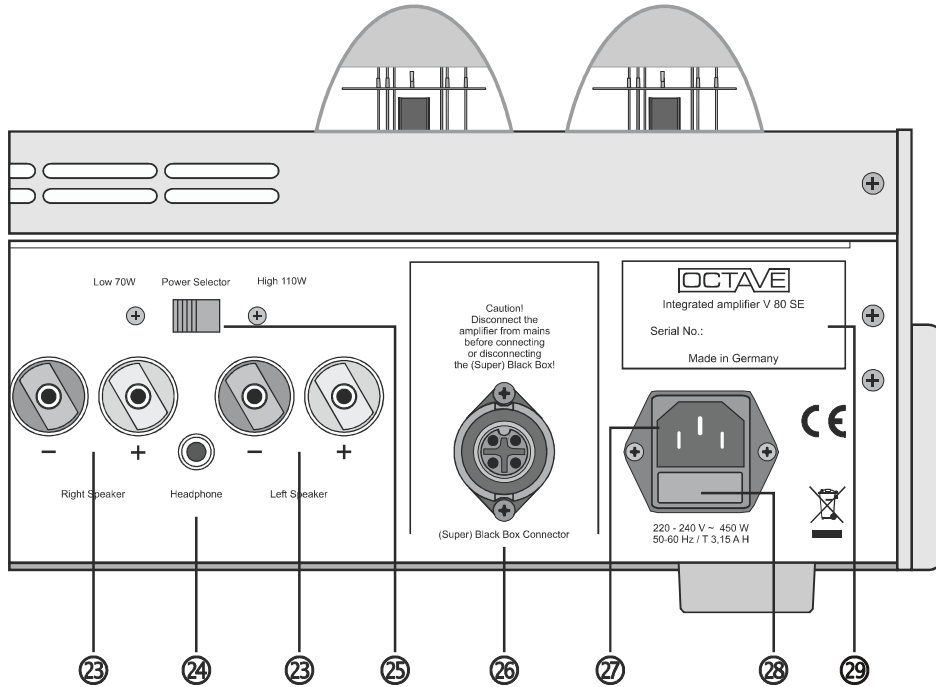

Legend	
②③	Loudspeaker outputs Speaker connection terminals. Red = positive terminal, Black = negative terminal The speaker negative terminal is connected to ground
②④	Headphone 6.3 mm stereo jack socket for headphones with an impedance of between 30 and 2000 ohms (see chapter 7.5).
②⑤	Power Selector Sliding switch to adjust the output power of the V 80 SE (see chapter 7.6).
②⑥	Black Box connection  The Black Box is an outboard power supply upgrade for the power amplifier section (see chapter 12). You should switch off V 80 SE using the power switch before connecting and disconnecting a Black Box!
②⑦	AC supply socket IEC socket with external fuse The fuse is located in a pull-out compartment underneath the socket. You can open the fuse compartment after removing the plug.
②⑧	Fuse For 220/230 V: 3.15 A slow-blow Type H (5 x 20 mm) For 240 V: 3.15 A slow-blow Type H (5 x 20 mm) For 110/120 V: 6.3 A slow-blow Type H (5 x 20 mm) For 100 V: 6.3 A slow-blow Type H (5 x 20 mm)
②⑨	Model identification plate Model and serial number

6. RECOMMENDED SETTINGS

6.1. Optional Phono - MC/MM

Rear panel connections

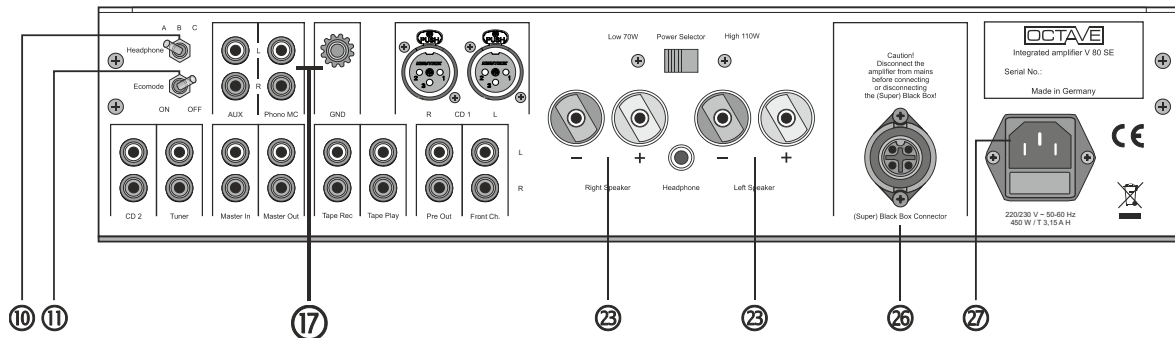

Headphone [10] switch to position A = off. Ecomode [11] switch to position off. Turntable ground cable (if present) to GND socket [17]; RCA cable from turntable to Phono Input [17] (left channel: white, right channel: red) Speaker cables and power cable are connected to [23] + [27].

Front panel switch settings

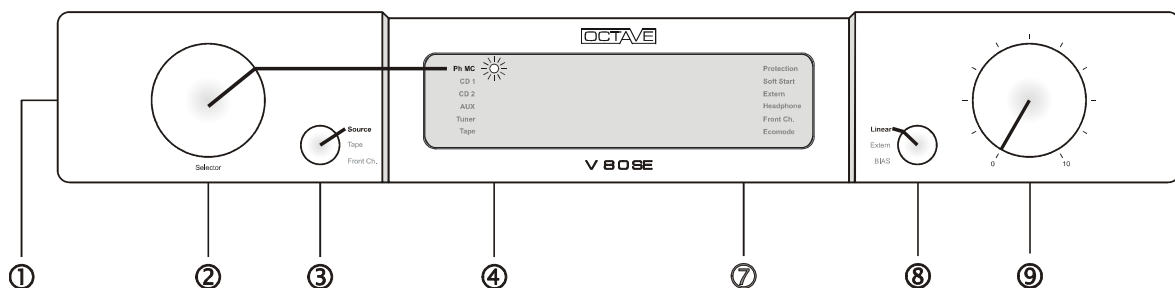

Power switch [1] on "I"; secondary input selector [3] on Source; turn input selector [2] until the Phono LED illuminates in [4], mode selector [8] on Linear, volume control [9] initially on "0" (see Chapter 11 "Phono option").

6. RECOMMENDED SETTINGS

6.2. Line playback such as CD 1, (CD 2, AUX, Tuner is adjusted accordingly)

Rear panel connections

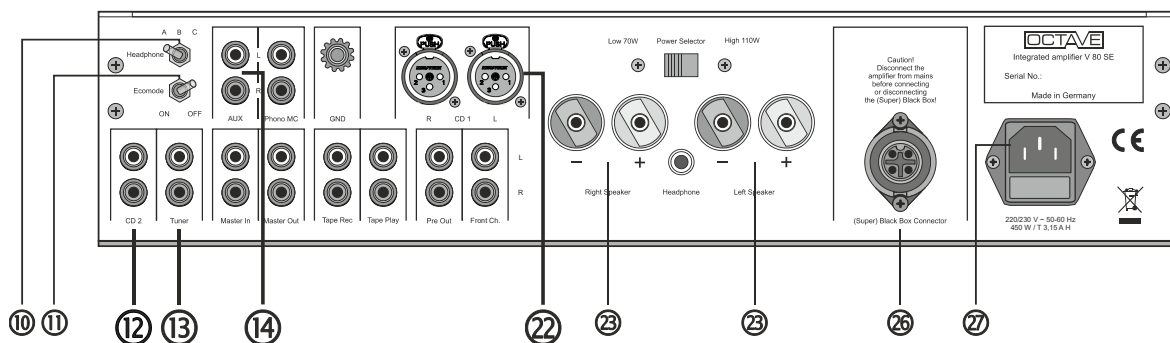

Instructions for CD1:

Headphone [10] switch left = off; Ecomode [11] switch right = off. Connect XLR cable from CD player to XLR input [22]. (You might need to push the locking lever down to plug the XLR in. You will certainly need to push the locking lever down to remove the XLR.) Speaker cables and power cable are connected to [23] + [27].

The XLR input is a genuine balanced input that meets studio standards. The input sockets are female. You can use a cable without a continuous ground connection.

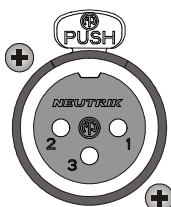

- 1 = Ground
- 2 = +
- 3 = -

Front panel switch settings

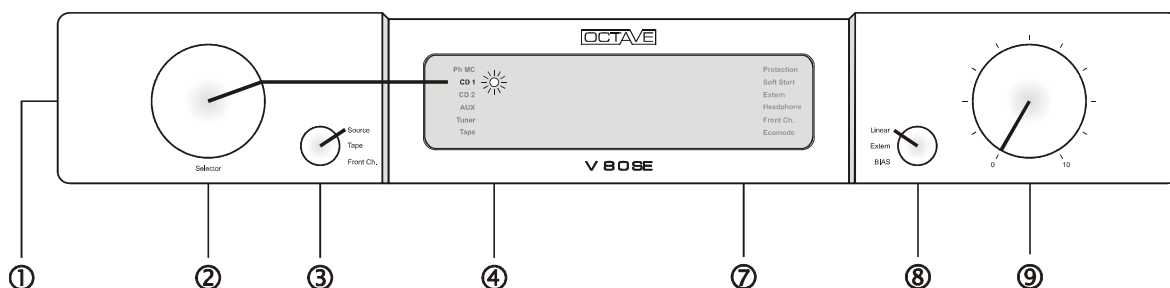

Power switch [1] on "I"; secondary input selector [3] on Source. Turn input selector [2] until CD1 LED illuminates in [4]. Mode selector [8] on Linear, volume control [9] initially on "0"

6. RECOMMENDED SETTINGS

6.3. Tape playback and record

Rear panel connections

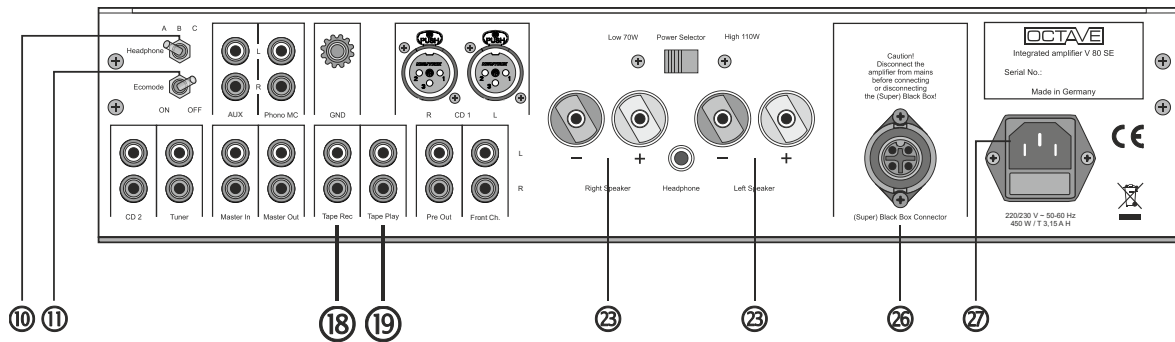

Headphone [10] switch left = off, Ecomode [11] switch right = off.
 Connect the tape recorder output (Line Out) to Tape Play [19]. Connect the tape recorder input (Line In) to Tape Rec [16] (left channel: white, right channel: red).
 Speaker cables and power cable are connected to [23] + [27].

Front panel switch settings

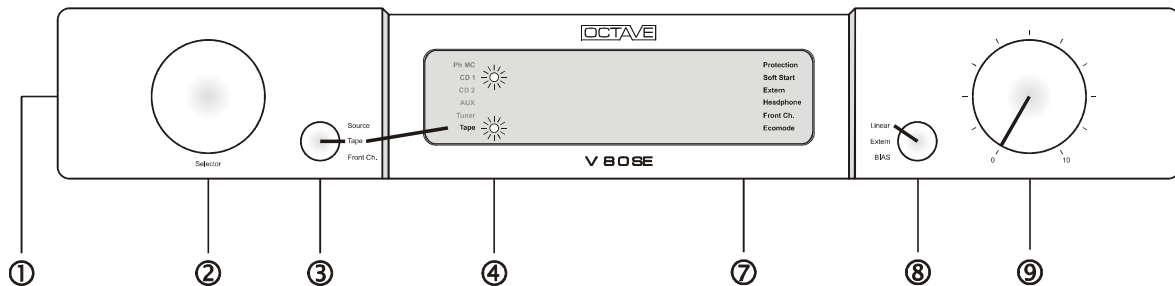

Power switch [1] on "I", mode selector [8] on Linear", volume control [9] initially on "0"

Tape playback

Secondary selector switch [3] on Tape". The Tape LED [4] illuminates. Tape playback will take place with these settings. (The position of the input selector [2] is irrelevant).

Tape record

Turn input selector [2] to the input from which you wish to record. The source selected with the input selector [2] is always sent to Tape Rec [18]. It does not matter whether the secondary input selector [3] is in the Source or Tape position.

Please note: The "Front Channel" signal is also available at the Record output [18]. Off-tape monitoring is not possible in this setting (see chapter 6.4).

Off-tape monitoring/Tape Monitor

The off-tape monitoring facility allows you to listen to the recorded signal in real-time while a recording is taking place. To do this, you must turn the secondary input selector to Tape [3]. Switching between Source and Tape will not affect the actual recording.

6. RECOMMENDED SETTINGS

6.4. Front Channel replay (multichannel)

Rear panel connections

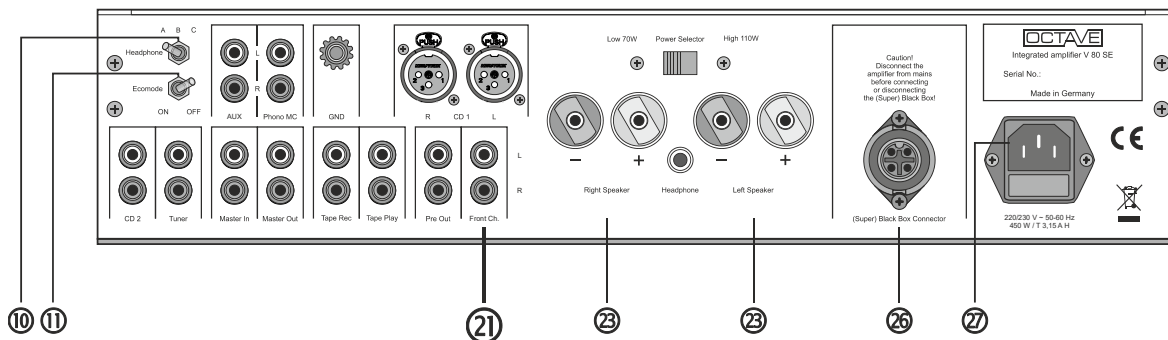

Headphone [10] switch left = off, Ecomode [11] switch right = off. Connect the analogue Front R + L outputs on your multichannel receiver/DVD player to the Front Channel R + L [21] inputs on your amplifier. Speaker cables and power cable are connected to [23] + [27].

Front panel switch settings

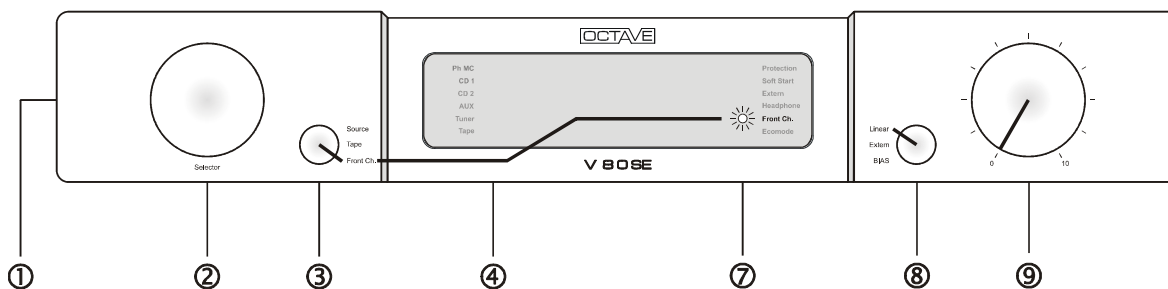

Power switch [1] on "I", secondary selector [3] on "Front Ch.". The input selector [2] does not operate and there are no LEDs illuminated in [4]. The Front Ch. LED illuminates in [7]. Mode selector [8] on Linear.

This mode bypasses the V 80 SE's volume control. The volume of a multichannel system is normally controlled digitally by the receiver/processor preamplifier. Please ensure therefore that your multichannel unit is switched on and that its volume setting is not too high when you activate the "Front Channel" function.

Note: Although you can record the multichannel input signal via Tape, the tape monitor function is not available, as turning the secondary input selector [3] to Tape switches the "Front Ch." off.

7. ADVANCED FUNCTIONS

7.1. Linear mode

In Linear mode, the power amplifier section of the V 80 SE is connected to the internal preamplifier and to the input selector switch. This is the V 80 SE's normal operating mode – as an integrated amplifier. The mode selector [8] must be on Linear.

7.2. "Extern"-function: Separating the pre- and power amplifier

Being able to separate the pre and power amplifier provides you with a number of useful options. The two most common of these are 1) inserting an external analogue signal processor/equalizer and 2) using the V 80 SE as an independently adjustable power amplifier together with an external preamplifier.

Two relays inside the V 80 SE are responsible for separating the pre and power sections. They are actuated when the selector knob [8] is switched to the Extern position. You do not need to remove any external links or jumpers.

Front panel switch settings

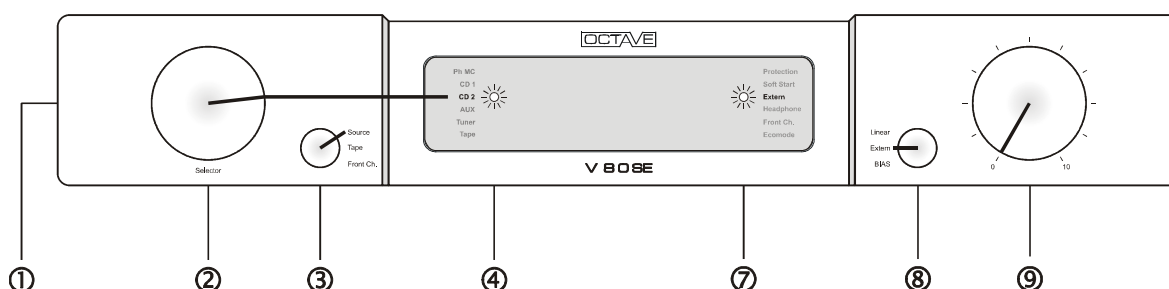

Rear panel connections

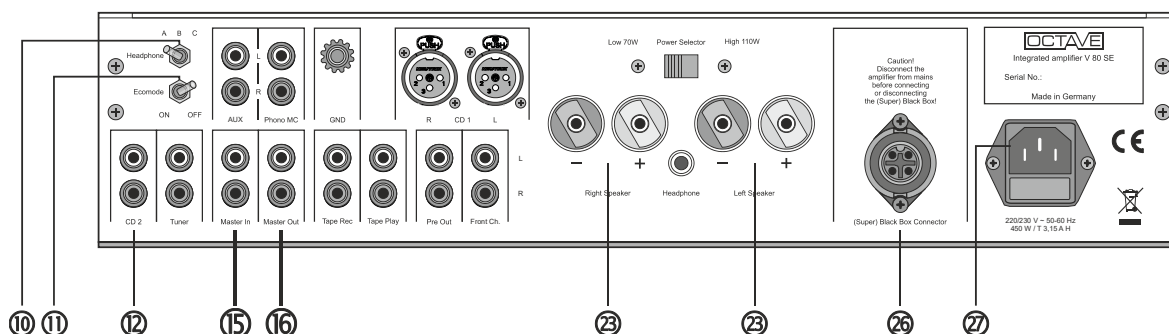

- 15 **Master In** Input to power amplifier when Extern function is on.
- 16 **Master Out** Preamplifier output when Extern function is on.

7. ADVANCED FUNCTIONS

7.2.1. Inserting an external equalizer

External equalizers or signal processors are used to counteract the effects of the listening room or to adjust the loudspeakers to suit the listening room.

Note: In the "Extern" setting, the external processor is connected to the power amplifier input. You may hear pops and clicks when you switch the processor on and off, irrespective of the technology employed by the processor. We therefore recommend that you switch the processor on before you switch on the V 80 SE, or before you switch the "Extern" function on. (See Chapter 3.7 Connection options: overview). Please check the instruction manual for your effects unit/processor for information on the unit's analogue inputs and outputs.

7.2.2. Using the V 80 SE as a 2-channel power amplifier with an external preamplifier

The Extern function also allows you to use the V 80 SE as an independently adjustable power amplifier together with an external preamplifier. Connect the preamplifier to Master In, with the mode selector knob [8] in the Extern position. In this mode, you retain the use of the V 80 SE's volume control. When using this option, you should generally set the volume control on the V 80 SE to maximum and adjust the volume with the external preamplifier.

7.2.3. Using the V 80 SE in bi-amped systems – application 1 The V 80 SE as an independently adjustable power amplifier

Bi-amping is a variant of the above. In a bi-amped system, the V 80 SE power amplifier section would typically power the mid-high section of your speakers, with a second power amplifier driving the bass section. Ideal are a preamp with two outputs per channel and at least one power amplifier with its own volume control. You need to be able to adjust the sensitivity of at least one of the amplifiers in order to balance the output levels of the two power amps. You can use the volume control on the V 80 SE to do this. The calibrations on the front panel will enable you to reliably repeat your settings. Connect the V 80 SE as shown in chapter 7.2.2 Connect the bass power amplifier to the second output on the external preamplifier.

Possible configurations of the V 80 SE in bi-amped systems

Option 1: V 80 SE in the external mode as independently adjustable power amplifier

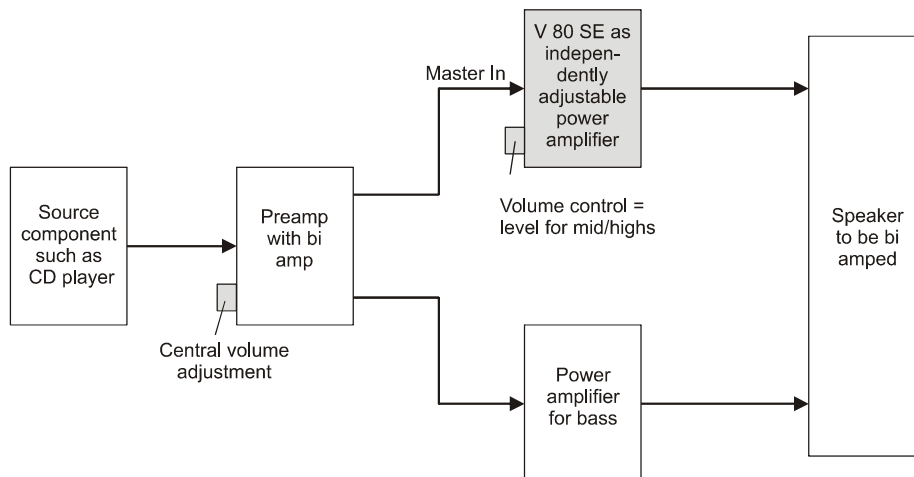

7. ADVANCED FUNCTIONS

7.3. Adjustable preamplifier output – Pre-out

7.3.1. Using with a subwoofer

The adjustable preamplifier output is most commonly used to drive an active stereo subwoofer. This must be equipped with its own volume control. The Pre Out is decoupled via a separate buffer to prevent the subwoofer from affecting the V 80 SE. The input impedance of the subwoofer is therefore uncritical.

The Pre Out does not have a separate muting function to prevent switch-on or switch-off noises from the V 80 SE. This is not normally needed, however, since the active crossover in the subwoofer electronics will block unwanted DC and low frequency signals.

7.3.2. Using the V 80 SE in bi-amped systems – application 2 The V 80 SE as a central control unit

Another option provided by the adjustable Pre Out is Bi-amping via the V 80 SE's internal preamplifier. The V 80 SE would ideally handle the mid/high portion of a bi-amped setup, using a second power amplifier fitted with its own volume control to take care of the bass. In this configuration, switch-on/off noises from the Pre Out may prove to be a problem. The best way to deal with this is to make sure you switch the V 80 SE on before the external power amplifier and then switch the units off in reverse order.

If you do not have a power amplifier with a separate volume control, you should match the input sensitivities (or gain) of each amplifier. You will normally find the gain listed in dB in the amplifier's specification. The figures for each power amplifier should be within 2dB of each other.

The ideal gain of the external power amplifier is 32 dB +/-2 dB.

Possible configurations of the V 80 SE in bi-amped systems

Option 2: V 80 SE as central control unit

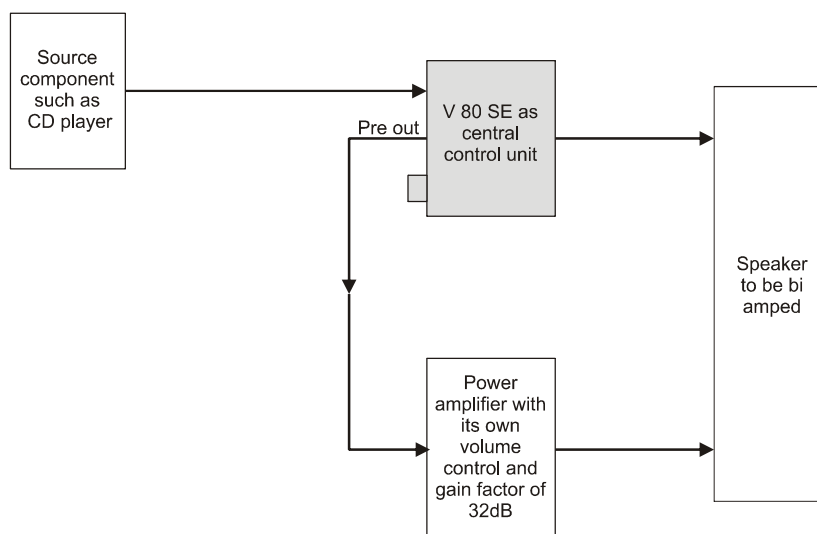

7. ADVANCED FUNCTIONS

7.4. Ecomode – soft-start and reduced power consumption mode

The Ecomode is a safety and energy-saving feature that automatically switches off the amplifier's tube circuitry during breaks of more than approximately 10 minutes. Ecomode reduces the overall power consumption of the amplifier to under 30 W, compared with 180 W in normal operation. When it detects a signal, the V 80 SE reactivates automatically and is ready for use again within approximately 60 seconds.

Rear panel switch settings

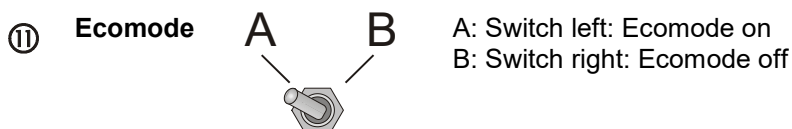
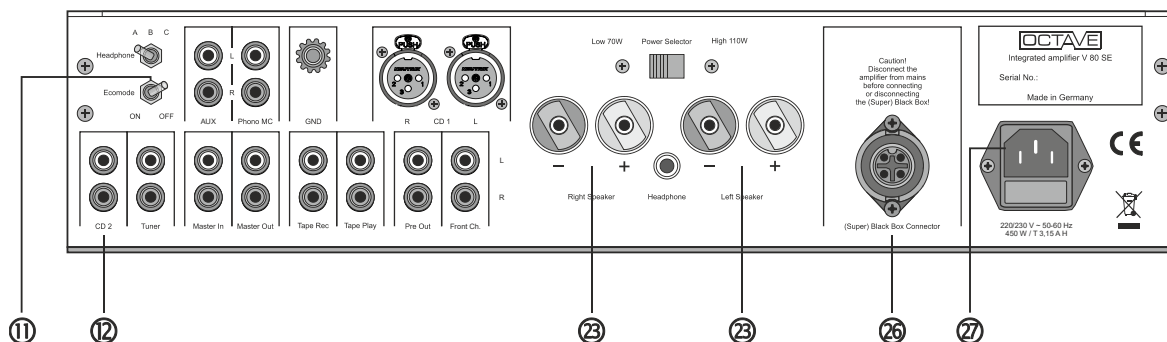

Front LEDs

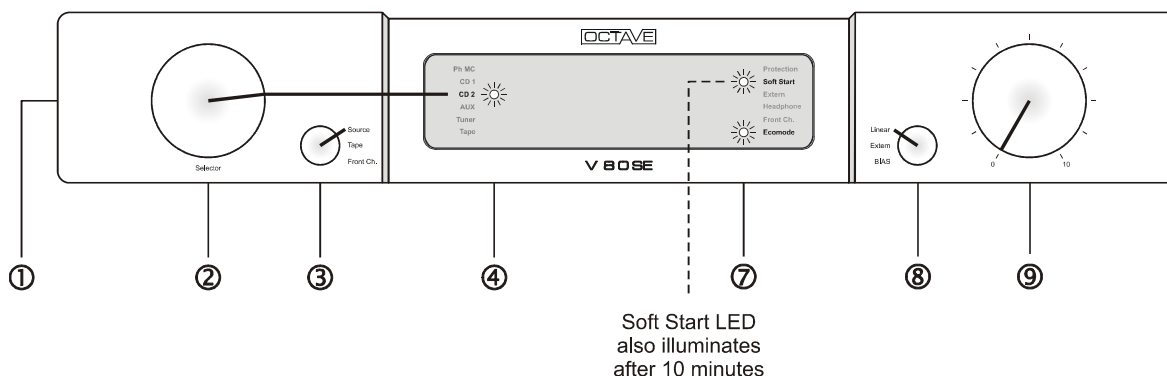

Ecomode is signal-actuated; after an approximately 10-minute silence, Ecomode switches in automatically. The soft-start LED [7] illuminates to show that Ecomode is active. As soon as the Ecomode circuit detects the presence of an input signal (from the CD player, for example) it will automatically power the V 80 SE up. The process takes approximately 60 seconds, after which time the soft-start LED will extinguish to show that the V 80 SE is ready for use.

Note:

If you switch the V 80 SE on with Ecomode active, it will go through the restart procedure. If it fails to detect a music signal, it will shut down after approximately 10 minutes.

7. ADVANCED FUNCTIONS

As well as saving electricity, Ecomode has a number of other advantages.

- longer tube life
- reduced heating of the whole unit
- increased passive safety if the unit is left on by mistake

Ecomode is not the same as standby, however, because certain sections of the amplifier remain on:

- the tape loop (you can still make recordings, as described in chapter 6.3).
- the headphone amplifier stays on

Important! You cannot adjust the bias in Ecomode once the amplifier has powered down!

7.5. Headphone/speaker operation

Rear panel switch settings

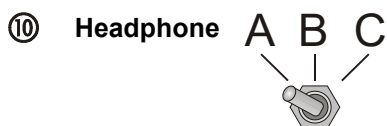
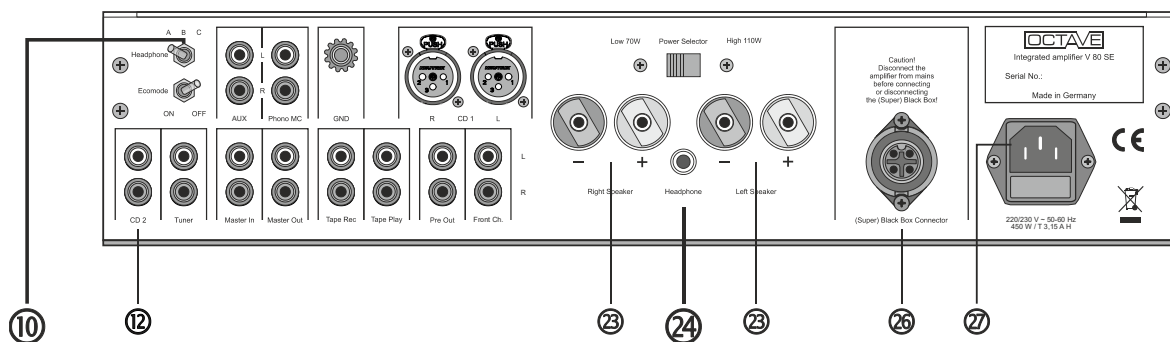

- A: Switch left: speaker playback
- B: Switch central: speaker + headphone playback
- C: Switch right: headphone playback, tube power amplifier is switched off.

Front LEDs

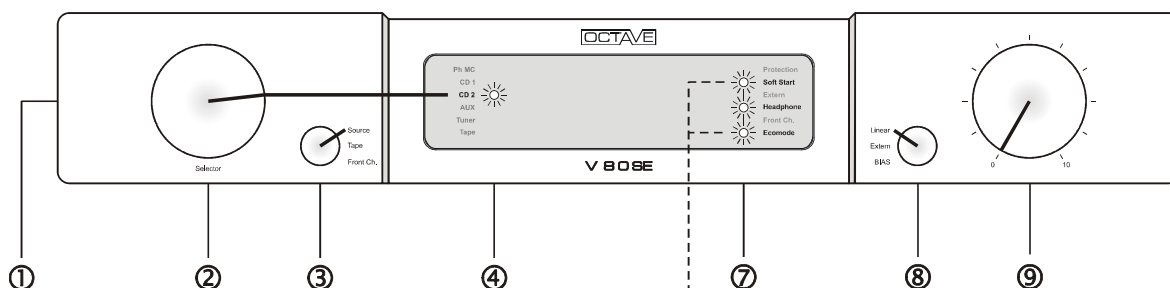

Soft Start and Ecomode LEDs illuminate additional when headphone switch is in position "C"

7. ADVANCED FUNCTIONS

The V 80 SE incorporates a separate solid-state headphone amplifier. The headphone output is via a 6.3 mm stereo jack and is suitable for high impedance headphones between 30 and 2000 ohms. If you have headphones with an impedance between 4 and 30 ohms, you should either use a separate headphone amp or connect them to the speaker outputs via an adapter.

The headphone - loudspeaker operation of the V 80 SE can be switched to 3 positions of the switch [10]:

- Position A only allows loudspeaker operation, the headphone amplifier is switched off
- In position B (middle position) the loudspeaker and headphone outputs are active. The "Headphone" LED lights up on the front in [7].
- In position C only the headphone output is active. Now, in addition to the "Headphone" LED, the "Ecomode" and "Soft Start" LEDs light up. The loudspeaker output is permanently switched off, the signal control of the Ecomode is out of order.

	<p>Note 1: If the V 80 SE is switched on with the mains switch and the headphone switch is in position C, the tube output stage of the V 80 SE does not start up. Loudspeaker playback is only possible by switching the "Headphone" switch to position A or B after the tube power amplifier has started up.</p>
---	---

	<p>Note 2: If you switch from headphone operation to loudspeaker operation and the Eco mode is ON, the V 80 SE does not start up until there is music signal again</p>
--	--

7.6. Power Selector, alternative output tubes

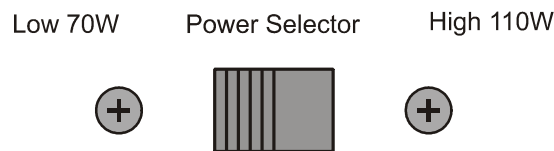

Position „HIGH“: KT150 / KT120
 Position „LOW“: KT88, 6550, KT90, KT100 (EL34 with Restrictions)

The Power Selector allows adjusting the V 80 SE in accordance to the output tubes. Position HIGH is reserved for the standard KT150 tubes as well as the KT120. In the HIGH position the V 80 SE is able to deliver up to 2 x 110 W Output Power. The slightly weaker tubes type KT88 or 6550 can be used in the position LOW. In this position the maximum output power is limited to 2 x 70 W to avoid overloading these tubes. The rather rare tubes of type KT90 and KT100 can be used also in the LOW position.

The EL34 can be used in the LOW Position in cases of speakers with impedance higher than 4 ohms.



Tubes of Type 6L6, KT66, 5881, EL519 and EL156 are not suitable for the V 80 SE. Before switching the Power selector turn OFF the mains.

After switching from power LOW to HIGH and vice versa the BIAS should also be corrected in case of using the same output tubes. Normally there is only a slight correction necessary. When using different tubes the BIAS has to adjust according to chapter 8.3.

8. TUBES

8.1. Tube layout

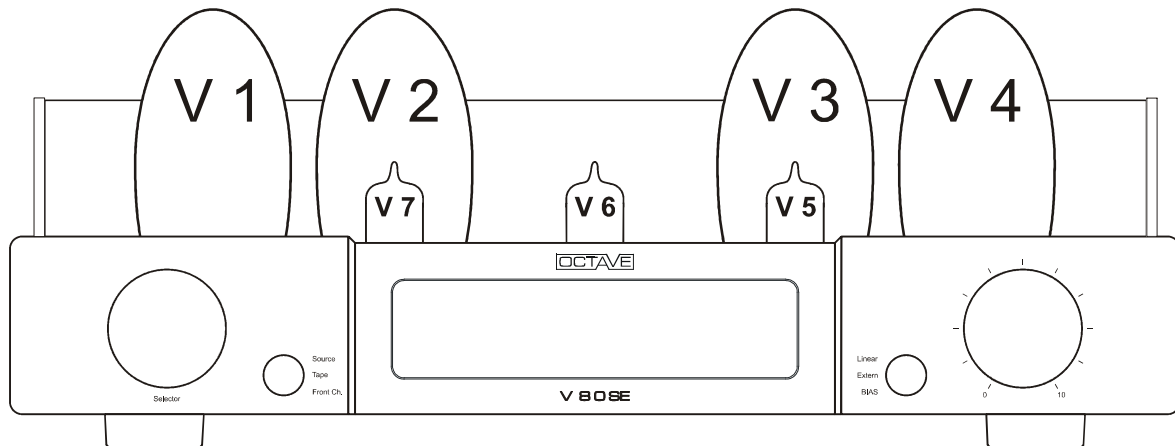

Output tubes: V1 - V4: optional KT88/KT120/KT150, subject to availability
 V1 + V2 left channel
 V3 + V4 right channel

Driver tubes: V5 + V7 ECC82 (12AU7) = power amplifier driver tubes
 V5 is for the right channel; V7 is for the left channel
 V6 ECC81 (12AT7, 6072) = input tube; V6 is used in both channels

The pentode output stage topology of the V 80 SE makes it possible to use a variety of output tubes. Because the specification limits of the tubes are never exceeded in pentode mode, weaker output tubes may also be considered. This is facilitated by the option of setting the bias current to two different values: low and high. Output tubes can roughly be divided into three classes – classic pentode output tubes for low and medium power amplifiers and modern, high performance pentodes for power amplifiers up to 150 W output.

Low Power tubes include: EL34, KT77
 Medium Power tubes include: 6550, KT88
 High Power tubes include: KT120 and KT150

Use Medium and Low Power Tubes in the position of the Power Selector LOW
 Use High Power Tubes in the position of the Power Selector HIGH



Note: Low Power tubes will not allow you to achieve the maximum output of the V 80 SE. We do not recommend using them in the V 80 SE except EL34, KT77

8. TUBES

8.2. Bias measurement system

The bias measurement facility makes it easy for you to check and adjust the idle current of the output tubes. Getting the bias setting right for all four tubes is critical for both the sound of the power amplifier section and for the service life of the tubes. This feature guarantees consistent sound quality over the entire lifetime of the output tubes.

That is why we have built this bias measurement facility into the V 80 SE – to allow you, the user, to carry out the adjustment yourself without the need for test equipment. The use of precision op amps makes it possible for you to set the bias to an **accuracy** of 0.3%, making it superior to any other method. Using selected output tubes only makes sense if the idle current is adjusted accurately, as is clearly shown in Fig. 1 Technical Data.

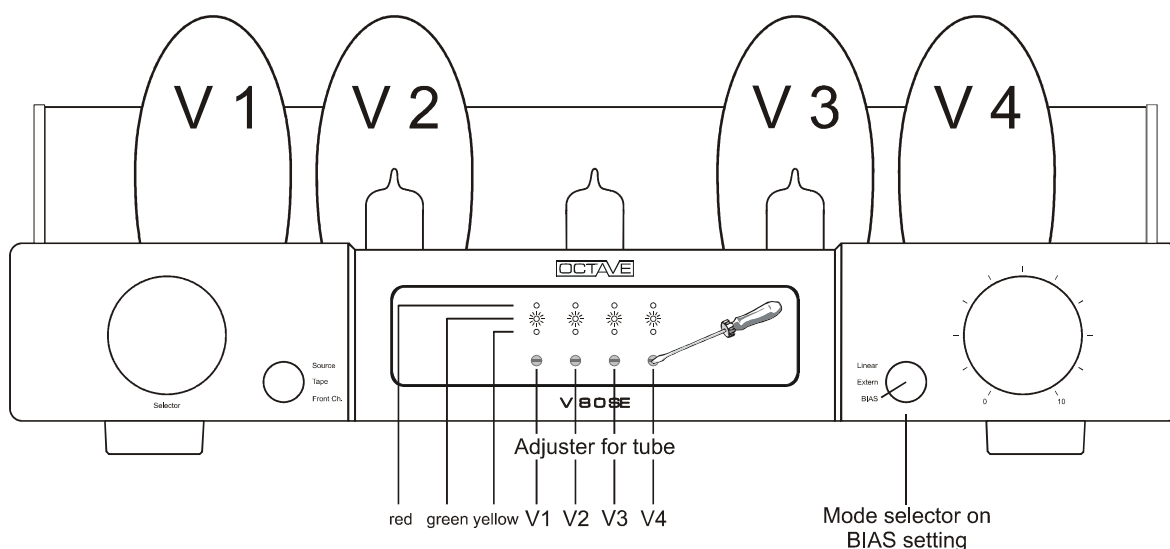

How to set the bias

Turn the mode selector knob [8] anticlockwise to the BIAS position to activate the measurement circuit. Signal/input selection is disabled. The 3 LEDs above each screw in the display panel show whether the bias setting is too low, correct, or too high. Use the small screwdriver supplied to adjust the bias. While you are setting the bias, the adjusters are illuminated to make them easier to see in unfavourable lighting conditions.

To increase the bias current to each output tube, turn the screwdriver clockwise.

The adjusting screws are fully insulated. There is no risk of electric shock and the adjustment procedure is completely safe.



Please turn the trimmers carefully and in small steps without tilting the screwdriver, otherwise there is a risk of damaging the controls
The bias adjustment should be made only when the tubes are heated. If the tubes are still cold, you will set wrong values

The LED display:

Red LED only	Setting is too high
Green + red LED	Setting is OK for KT150, KT120, KT88, 6550, etc. = BIAS High
Green LED only	Setting is OK for KT150, KT120, KT88, 6550, etc. = BIAS Med
Yellow + green LED	Setting is OK for EL34, 6CA7, KT77 = BIAS Low
Yellow LED	Setting is too low

8. TUBES

There is an upper adjustment limit to the "high" bias setting, which is indicated by the green and red LEDs lighting up at the same time, and a lower limit to the "low setting, where the yellow and green LEDs light up. The lower limit should be used with "smaller" output tubes such as the EL 34 and similar. The upper value, which provides a higher bias current for the output tubes, should be used with the more powerful tube types such as the KT150, KT120, KT88, 6550 (see chapter 8.2).

These tube types do not have to be operated at a high bias setting; they will work perfectly well on the low setting. However, certain loudspeakers may benefit from the higher bias current, as it will increase the damping factor and provide slightly better control of the movement of the speakers.

LED graphs

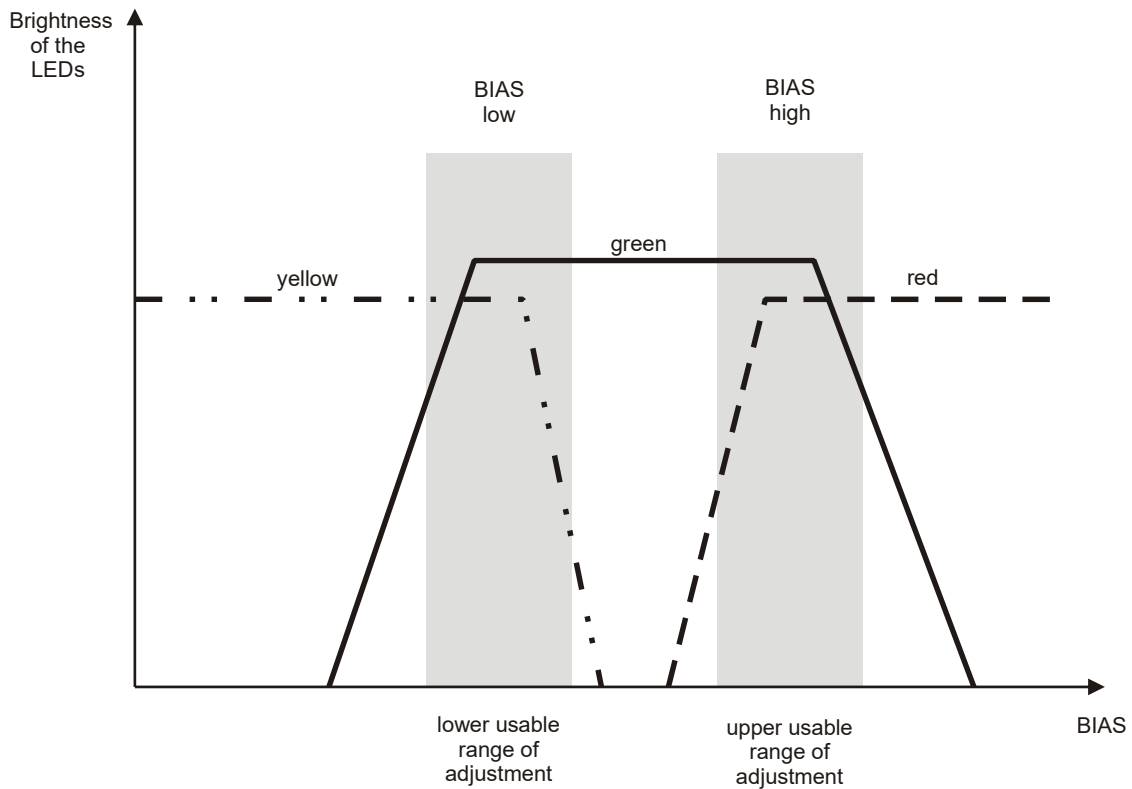

8. TUBES



8.3. Replacing the tubes

- **Driver tubes**

Replacement driver tubes require no adjustment.

- **Output tubes**

General procedure:

1. Switch the amplifier off and allow it to cool down for 10 minutes. Remove the old tubes and fit the new ones.
2.  Before you switch the amplifier back on, turn all bias adjustment screws (see chapter 8.3) counter clockwise (this greatly reduces the anode current). You will hear a click when the screws reach the minimum setting. These screws are three-turn potentiometers, i.e. it takes three revolutions to go from the maximum to the minimum setting.
3. Switch the amplifier on and turn the mode selector switch [8] to the BIAS position. Following the soft-start phase, all 4 "minus" LEDs (yellow) will illuminate. If at this stage any of the LEDs are green or red, this indicates a faulty tube that must be replaced. After a 10-minute warm-up period, set the bias as explained in chapter 8.3.
- 3.1.  Original Octave tubes
There is no need to burn in original Octave replacement tubes. Allow the tubes 10 minutes to warm up and adjust them to the appropriate setting for the tube type.
- 3.2. New, untested output tubes should be allowed a longer warm up period. You should adjust these tubes after about 20 minutes.

8.4. Running in the tubes

All OCTAVE equipment is subject to a 48-hour soak test at the factory to burn in the tubes. The tubes are preselected for use in each particular model.

New tubes can take up to three months to run in and start sounding their best.

Daily use is beneficial in speeding up this process but is not mandatory. Continuous operation does very little to help reduce the running-in time and is therefore ***not*** recommended.

8.5. Tube service life

- Thanks to the protection circuits and soft-start electronics, the output tubes in your amplifier should achieve a service life of up to 5 years.
- Driver tubes can be used for 10 years or even longer.
- Because tubes have different service lives, you will never have to renew the entire tube complement at the same time. The facility for setting the bias for each output tube individually makes it unnecessary to use matched sets of output tubes. You can replace output tubes individually if you wish.
- Some tubes need a long time (up to 300 hours) to achieve their optimum sound quality. Depending on how long the tubes have been stored, it may be necessary to adjust the bias several times in the first two to three weeks after installing them.

9. PROTECTION SYSTEM

The V 80 SE features a comprehensive electronic monitoring and protection system. This system will automatically switch the V 80 SE off if a fault occurs in the power section. The protection system has been designed to keep the unit safe from the consequences of overloads of any kind and to protect the output tubes from current surges.

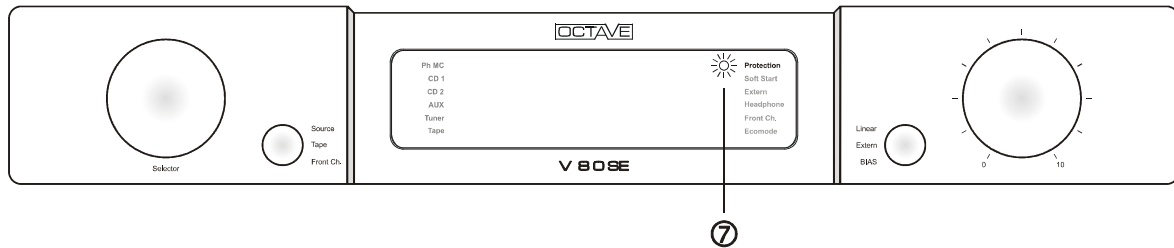

The red "Protection" LED lights up in [7] to show that the protection system has tripped. The amplifier will not play music once the protection system has tripped and you will not be able to check or adjust the bias setting. The bias LEDs will show "yellow" for each of the four output tubes. If a Black Box or a Super Black Box is connected to the V 80 SE, the front panel (operate) LED of the Black Box / Super Black Box will go out. If the Super Black Box is connected, tripping the protection system will automatically activate the discharge circuit of the Super Black Box (see chapter 12).

The following conditions can cause the protection system to trip:

- Overdriving the V 80 SE to excessive levels or with excessive levels of low frequency.
- A speaker cable short circuit while the speakers are being driven at high listening levels.
- A fault in one or more of the output tubes.
- A fault in one of the preamp tubes which overloads the affected channel.

Once the protection system has cut in, the only way you can turn the V 80 SE back on is to turn the on/off switch off and then on again. Allow the unit two minutes to cool down before switching it back on. If possible, identify and eliminate the cause of the problem (see chapter 13 "Troubleshooting"). If it is not clear what has caused the protection system to trip, we recommend you check the bias before attempting to use the amplifier again. Tube faults can often result in widely varying bias settings. When these settings exceed a particular value they can cause the protection system to trip.

10. REMOTE CONTROL

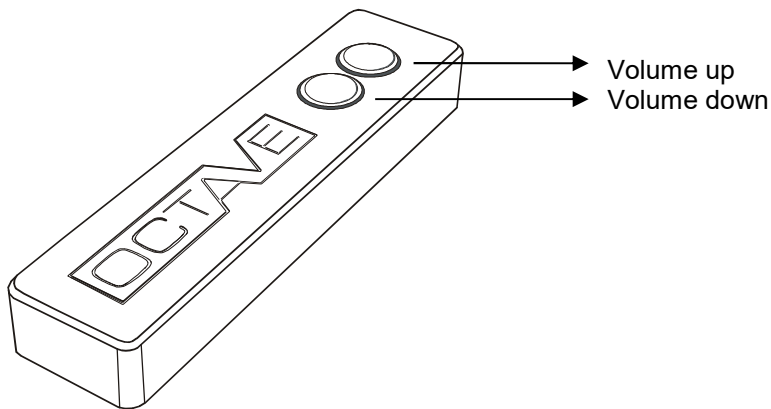

Procedure Changing the Batteries

1. Remove the bottom plate (three screws) with the supplied Allen screwdriver
Change the batteries (2 x type AAA 1.5 V alkali-manganese / alkaline)
Please take care not to push the buttons of the remote control while inserting the new batteries.
2. If it still happens that the remote control does not work after changing the batteries, remove the new batteries and wait for the minimum of 30 minutes. After half an hour you can insert the new batteries again and the remote control should work.
3.  Install the bottom plate again, tighten the screws not too hard
Please don't trash the old batteries. Batteries must be disposed of as special waste. Stores that sell batteries should provide containers for the collection of used batteries

11. OPTION PHONO MC / MM

A phono MM or MC board is available as an option for the V 80 SE. This additional board is connected internally to the phono input. When the board is installed, this input can no longer be used as a line level input.

The phono preamplifier incorporates passive RIAA equalization with an active, 2nd order subsonic filter. The phono preamplifier uses semiconductor technology throughout.

The subsonic filter suppresses undesirable low frequency signals in the sub-audio range caused by warped disks and pickup/tonerarm resonances. The passive, zero feedback equalization guarantees the absolutely natural tonality of the phono preamplifier. Traditional equalization topologies lacking effective subsonic filtering and carrying out the equalization within the negative feedback loop can never achieve better than average sound quality, particularly as subsonic interference will cause substandard reproduction of the lower registers.

Two phono boards are available, one for MC and one for MM. Installation is straightforward and can be carried out by your authorized retailer or a specialist workshop.

The MC board is recommended without reservation for use with virtually all MC systems and has been optimized for both low and medium output systems. The MM board has a standard input impedance and is thus suitable for all high output MC and MM systems.

Specification:

Input impedance:	MC 500 ohms, MM 47 kohms
Signal-to-noise ratio:	MC 75 dB, MM 90 dB
Input sensitivity:	MC 0.5 mV, MM 4 mV
Subsonic filter:	-12 dB/octave, 20 Hz Roll off frequency

12. OPTION (SUPER) BLACK BOX

Description

With the Black Box technology OCTAVE offers an instrument for optimizing the OCTAVE amplifier in respect to the speaker. This flexibility is a unique feature of the OCTAVE brand.

The dynamic and tonal stability of an amplifier is strongly dependent upon the stability and capacity of the power supply, therefore the Black Box and Super Black Box were developed as external upgrades to the OCTAVE amplifiers' power supply storage capacitors by increasing their capacitance by a factor of 4 (Black Box) or 10 (Super Black Box), respectively. This is a tremendous benefit if the speaker is difficult to drive. Loudspeaker efficiency is made less critical, while the amplifier is enabled to handle speakers with minimum impedances as low as 2 ohms. The power supply capacitance increase realized via use of the Black Box or Super Black Box stabilizes current delivery and reduces the impedance interaction of the load. This improves dynamic range, separation, depth, soundstage size and articulation, rendering the musical reproduction clearer throughout the entire frequency range. The amplifier remains unaffected by mains variations and interferences due to the noise filtering characteristics of the capacitors.

12.1. The Black Box option

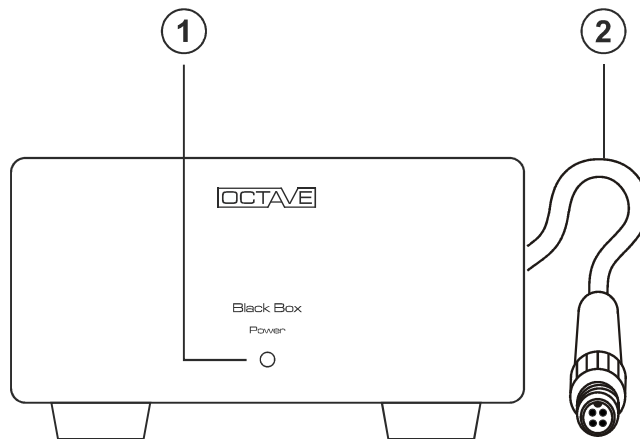

Legend

(1)	Indicator LED	The LED illuminates continuously when the power amplifier is on. The LED goes out when the protection circuitry trips. This is normal, as the protection circuitry cuts the power to the amplifier.
(2)	High-current plug	

12.2. Connecting to the amplifier



- Important! Before connecting the Black Box, switch **off** the unit using **the power switch and wait for 1 minute**.

When inserting the connector, guide the anti-rotation lug carefully into the mating recess in the socket.

- When you switch on the amplifier, the LED on the front panel of the Black Box will illuminate.

Note: The LED on the Black Box goes off when the amplifier's electronic protection circuitry is activated or the Ecomode has turned the unit down.

- Should you wish to disconnect the Black Box, switch off the amplifier first and **wait until the LED on the Black Box has gone out**.

12. OPTION (SUPER) BLACK BOX

12.3. The Super Black Box option

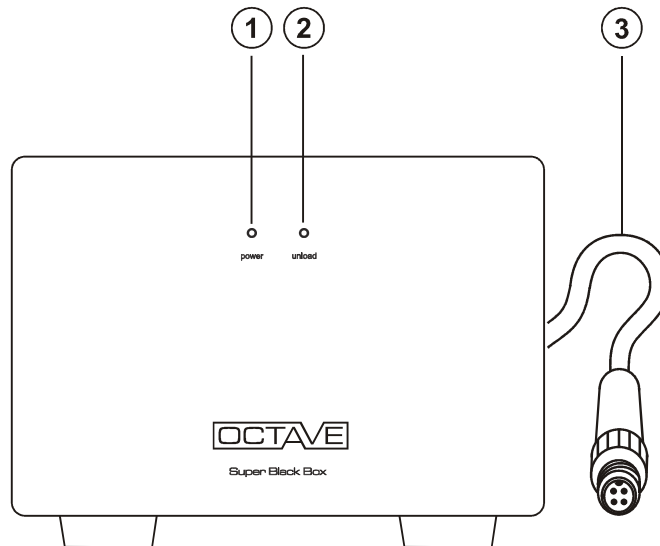

Legend

- | | |
|------------------------------|--|
| (1) Blue power LED | The blue “power” LED illuminates when the power amplifier is switched on via the amplifier’s power on/off switch. |
| (2) Yellow unload LED | The yellow “unload” LED (discharge control circuit) lights up for approximately two seconds after switch-off, in case the electronic protection is activated and if the amp is powered down through the Ecomode. The Super Black Box is equipped with a rapid discharge circuit, which discharges the unit’s electrolytic capacitors. The yellow LED indicates that that this procedure is taking place. The discharge circuit also activates if the SBB connecting cable is accidentally removed. This is to prevent the SBB maintaining its charge when it has not been properly disconnected. |
| (3) High-current plug | (Connection see Black Box). |

12.4. Technical Data

12.4.1. Black Box

Specifications

Weight	3.2 kg
Dimensions	185 x 100 x 310 mm (Width x Height x Depth) with cable clamp and angled cable.
Cable length	1 m with connector. Longer lengths are available upon request.

12.4.2. Super Black Box

Specifications

Weight	5.6 kg
Dimensions	200 x 150 x 350 mm (Width x Height x Depth) with cable clamp and angled cable
Cable length	1 m with connector. Longer lengths are available upon request.

13. TROUBLESHOOTING

13.1. Faults caused by external issues

13.1.1. Buzzing and hum in the speakers

■ **Possible cause: multiple grounds**

Hum in an audio system is often caused by several system components having their own separate grounds. It is particularly common in systems containing tuners, VCRs or satellite receivers, as these components are connected to an aerial. Because aerials and cables are always grounded, ground loops can form between the aerial connection and other grounded equipment. Other equipment that is normally grounded may include PCs with sound cards, and some CD/DVD players and DACs. Although the V 80 SE is grounded, its signal ground is a "floating" ground, which means that the V 80 SE cannot create ground loops itself. Hum can only be caused when it is connected to other items of equipment.

To fix the problem

Before trying to fix the problem, find out which of your system components is responsible for generating the hum.

Procedure:

- Unplug all source equipment, including any equalizer if used, from the V 80 SE, leaving only the loudspeakers connected.
- Reconnect the components back to the V 80 SE one at a time. As soon as the hum reappears, you have two grounded components connected to the V 80 SE. You must now unplug your components in reverse order to find out which of them is grounded.

Usually, the hum will still appear even when the problem components are switched off. The ground causing the problem is always connected, since it is not broken when the power switch is operated.

Now that you know which components are grounded, you can discuss the problem with your dealer. One option might be to use a signal-isolating filter on the aerials or cable networks. This devices do not normally have any adverse effect on the sound or picture quality of tuners or TVs. Other possible solutions could include using an isolating transformer or an isolating device offering complete galvanic isolation. Please seek the advice of a specialist.

Power strips with built-in filters, mains filters or replacement mains cables are not appropriate solutions.

Note

Switching power supplies are quite common nowadays. These are often fitted with a protective earth terminal (PET) and an RFI filter. When using these devices, the protective earth terminal **must** be connected to the wall socket. You must never remove this protective terminal, as doing so could cause high levels of radio frequency interference to enter your system, which could affect the operation of other digital equipment, including remote controls.

13. TROUBLESHOOTING

■ Possible cause: induction

Another possible cause of hum could be the stray field of a transformer generating interference in a device or cable. You can easily diagnose this problem by switching off the problem component.

To fix the problem

To reduce this kind of interference, move the transformer/component or the affected component/cable to a different location.

The transformer in the V 80 SE will not generate interference, as it is electromagnetically shielded and has a very low stray field.

■ "Phase" does not cause noise and hum

The mains polarity of the components in your system has no impact on noise and hum. That is a common fallacy. Swapping positive and negative in your mains plug will not make any difference to an earth loop. If it does, there is a fault with that component and you should not be using it.

13.1.2. Mains interference

Older fridges and 12V halogen lamps can produce strong radio interference when they turn on and off. Depending on the wiring in your home, this can result in clicks and pops in your loudspeakers.

To fix the problem

Modern domestic mains systems with a separate protective earth (PE) will normally suppress this interference. If you experience this type of switching interference, you either have a poor protective earth connection in your home or else your house does not use a PE system. In the latter case, you may not be able to eliminate switching interference entirely. In any event, the use of mains filters (in front of the device responsible for the problem) is certainly recommended.

13.1.3. Channels are not balanced

Level differences can have a variety of causes, although tubes are unlikely to be one of these.

1. The acoustics of the listening room may be affecting what you hear.
2. One of the drivers in your loudspeakers may be faulty.
3. There may be a faulty cable in your system

To fix the problem

You can trace the cause of this kind of problem by swapping speakers, cables, etc.

13. TROUBLESHOOTING

13.2. Faults caused by tubes, faulty tubes

Like other OCTAVE products, the V 80 SE is equipped with a double safety system. This means that the amplifier will be protected from damage if a component (tube) should fail and trip the electronic protection. The protection system protects the amplifier and the tubes from overload. This technology has proven its worth in recent years. *It has enabled us to reduce our overall failure rate (except for output tubes, which we are unable to control 100 percent) to virtually zero. OCTAVE equipment will achieve a service life of 10 to 15 years without needing to be serviced. We feel that this is particularly important aspect of tube equipment design, as many preconceptions still exist about the technology's durability and long-term stability.*

There are a number of reasons why tubes might fail at some point in their lifetime. You can fault-find tubes by examining their behaviour.

13.2.1. Mechanical tube faults that does not trip the V 80 SE's protection

- **The tube's heater filament no longer glows**

No matter whether it is a driver tube or an output tube, no tube can work without a properly functioning heater.

Output tube heater fault

When the heater system on an output tube fails, you will be unable to adjust the bias. The particular tube will refuse to move from the minus setting. A loose connection inside the tube could have caused the heater to fail. It may be possible to repair the connection by mechanical means. If the bias was previously badly misadjusted, the bias might "runaway", tripping the electronic protection.

This is why you should never turn the bias screws to the extreme right and leave them there. If you have not been able to adjust the bias satisfactorily, turn the adjuster screw back to its extreme left position.

Driver tube heater fault

If this happens, you will normally lose an entire channel, depending on which driver tube system is affected by the faulty heater. This can only be established by a visual examination. The heater filaments are often difficult to see inside the driver tubes, since they only protrude very slightly from the tube system. We use double triodes exclusively, i.e. there are always two identical tube systems within the glass envelope. Because each of these triode systems has its own heater, you should always be able to see two glowing filaments. If you can only see one, it means that the tube is faulty.

- **A tube has developed an air leak**

The glass envelope of all tubes normally contains a vacuum. In order to maintain the vacuum throughout the service life of the tube, there is a device inside the tube that absorbs the residual gas. It is called the getter pill. It normally takes the form of a small crucible near the top of the tube. It contains a substance known as the getter, which absorbs and permanently retains the residual gas. This device ensures that the tube maintains a high vacuum during its entire service life. Hairline cracks around the base and leaks around the socket pins can cause the tube to take in air. Because the getter is only able to absorb a finite amount of gas, it will soon stop working. The silver coating at the top of the tube will then begin to discolour. If a tube has an air leak, you will not be able to adjust its bias voltage. As soon as a certain amount of air leaks into the tube, it will stop working completely and the heater filament will burn through.

13. TROUBLESHOOTING

13.2.2. Tube faults that trip the protection system

The protection system continuously measures the current flow into the four power tubes. Depending on the problem, this current may exceed a specified limit and cause the protection system to switch the power stage off. The red protection LED will light up to show that this has happened. Once the protection circuit has been tripped, you will no longer be able to measure the bias of the power tubes and your amplifier will not produce any output. Exceeding the specified current limit can have a variety of causes.

■ Faulty output tube

Aging and mechanical stresses from rough handling during transport can create an unwanted connection inside the tube, which can lead to failure of the tube.

How can you recognize a faulty tube? If you do not know what fault caused your amplifier to cut out, it is a good idea to disconnect the speakers and switch the V 80 SE off and on again. Before switching it back on, turn the mode selector to the BIAS position. Now check the correct operation of the tubes via the bias display. If the tubes are good, the sequence of events will be as follows:

- Four LEDs illuminate until the soft-start phase is complete.
- After the soft-start phase, the power tubes will begin to heat up and will visibly glow as current flows into the tubes. After approximately one minute, the bias display should read "green".
- A fault in one of the power tubes would result in an uncontrolled rise in current, which would cause the top, red bias LED of the relevant tube to illuminate after a short time. A further rise in current to the tube would then cause the protection system to trip. Should this happen, switch the V 80 SE off and replace the problem tube.

■ Faulty driver tube

In very rare cases, a problem with one of the driver tubes can cause the V 80 SE to switch off. You can use the bias display to troubleshoot problems in the driver stage. The procedure is the same as the one described earlier, although the display will behave differently after the amplifier has warmed up. If one of these tubes is indeed responsible for the problem, both output tubes in the affected channel will behave erratically. This behaviour may take the form of short, rapid changes in LED colour - from yellow to green and red and back again. If the bias of both output tubes in one channel appears unstable, one of the driver tubes is generally responsible.

■ Tube faults that degrade the sound

These faults are relatively uncommon and usually a result of a fault already described above. Thanks to the controlled soft-start circuitry, the tubes will retain their tone throughout their working life.

The V 80 SE's sophisticated, low-noise power supply circuits push hum and noise down to negligible levels. Tubes do not inherently produce hum or hiss: these problems are simply side effects of older, classic tube technology.

Noise, crackling or similar undesirable noises can be caused by residual gas or other residues in the tubes. This kind of noise does not often reach a level that could be considered annoying, although the nearer to the "front" the particular tube is, the more it will tend to make itself felt. In the V 80 SE, this would be tube V 6. As it is rare for both systems in a double triode to be equally affected, the noise levels in each stereo channel will be different. If you experience noise that is louder on one channel than on the other, the first thing to do is to change the V 6 tube.

14. TECHNICAL DATA

14.1. In- and Outputs

In- and outputs	
Inputs	6 x RCA (including the Home Theatre Bypass input) One RCA input can be fitted with the optional either MM or MC Phono Input Board 1 x XLR
Outputs	1 x regulated Preamplifier output (RCA), 1 x Tape Record (RCA) 1 x Headphone output 1 x Loudspeaker output The pre- and power amplifier sections of the V 80 SE can be operated independently from each other as well
XLR Sensitivity	0 dB relative to RCA
XLR pin assignment	1 = ground, 2 = positive, 3 = negative
Power amplifier	
Output	100 W RMS, 130 W Peak / 4 ohms one channel
Frequency response	10 Hz – 80 kHz
THD	< 0.1 % at 10 W / 4 ohms
Signal-to-noise ratio	- 103 dB
Gain	38 dB
Headphone amplifier	
Output Voltage	10 V RMS / 300 ohms
Frequency response	10 Hz – 150 kHz
THD	0.0075 %
Preamplifier	
Input sensitivity	300 mV RCA and XLR
Input impedance	40 kohms RCA; 25 kohms XLR
Channel balance	0.5 dB to - 70 dB on volume control
Left/right crosstalk	60 dB
Input to input crosstalk	- 105 dB
Gain at pre out	+12 dB
General	
Power consumption	< 30 W in Ecomode, 180 W idle, 450 W full power
Weight	23,4 kg
Fuse	220 - 230 V ~: T 3.15 A slow-blow type H (5 x 20 mm). 240 V ~: T 3.15 A slow blow type H (5 x 20 mm). 110 - 120 V ~: T 6.3 A slow blow type H (5 x 20 mm). 100 V ~: T 6.3 A slow blow type H (5 x 20 mm).
Dimensions	Overall dimensions in mm 451 X 175 x 415 mm (W x H x D)

14. TECHNICAL DATA

Option Phono	
Input impedance	MC 500 ohms, MM 47 kohms
Signal-to-noise ratio	MC 75 dB, MM 90 dB
Input sensitivity	MC 0.5 mV, MM 4 mV
Subsonic filter	-12 dB/oct., 20 Hz roll off frequency

14.2. Dimensions

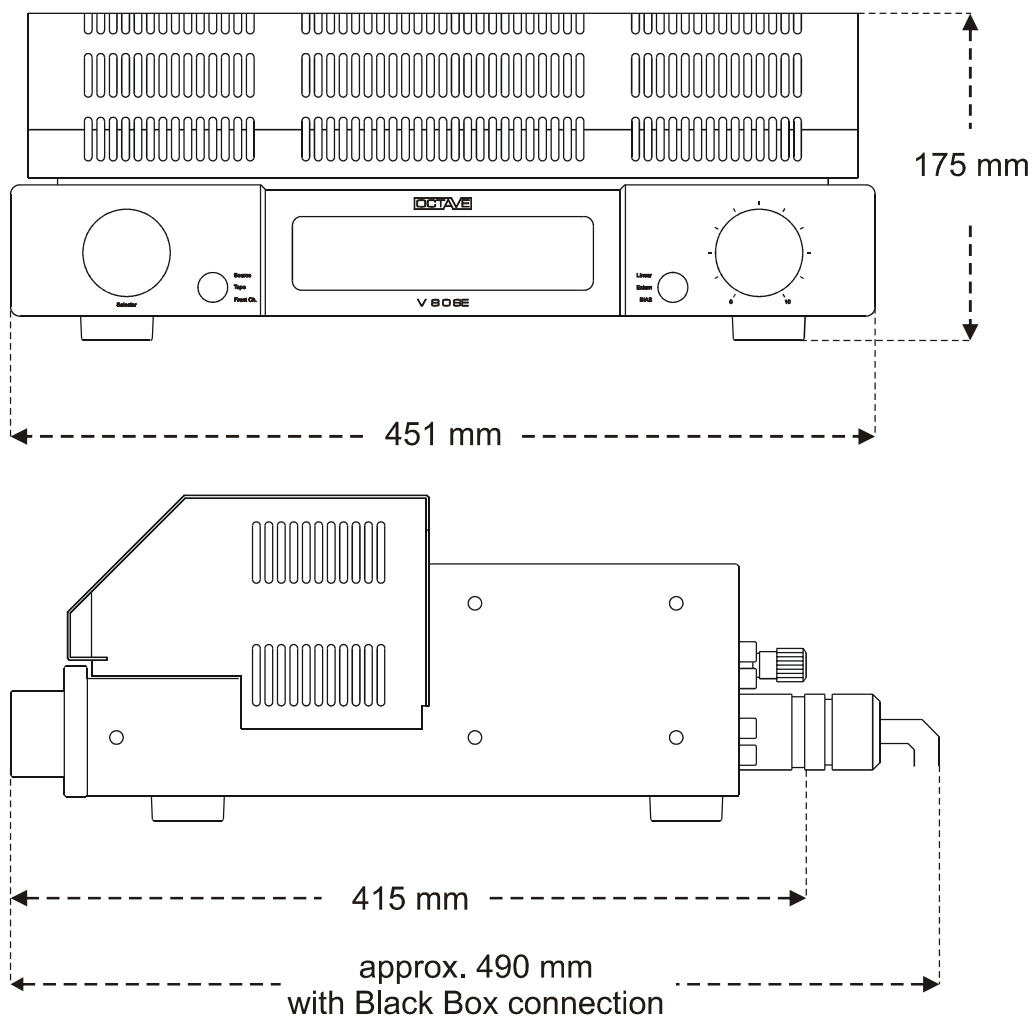

14. TECHNICAL DATA

14.3. Diagrams

THD at 4 V into 6 ohms from 30 Hz to 20 kHz at a variety of bias settings

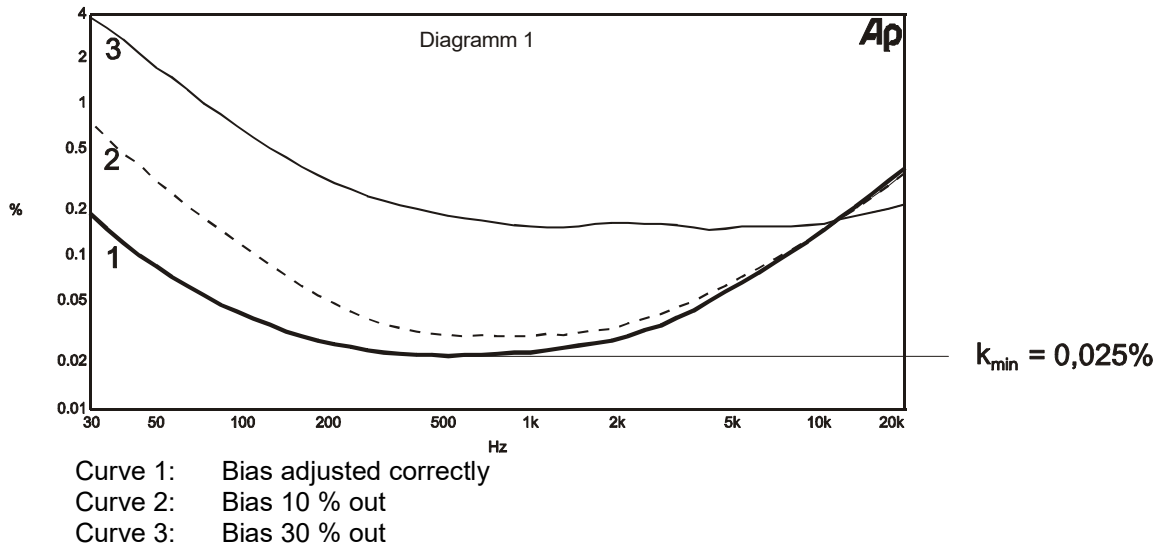

Graph 2: Frequency response, 4 V into 4 ohms

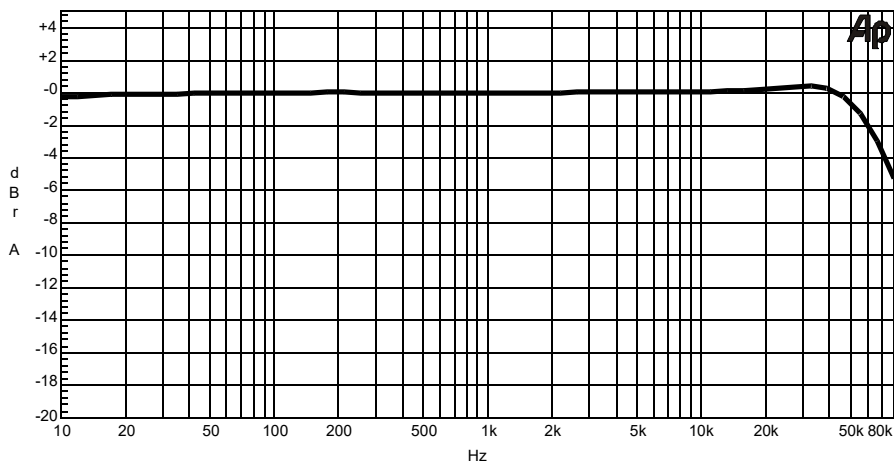

The Frequency response curve clearly shows the low frequency extension of the V 80 SE (flat to below 10 Hz).

14. TECHNICAL DATA

Graph 3: Distortion spectrum

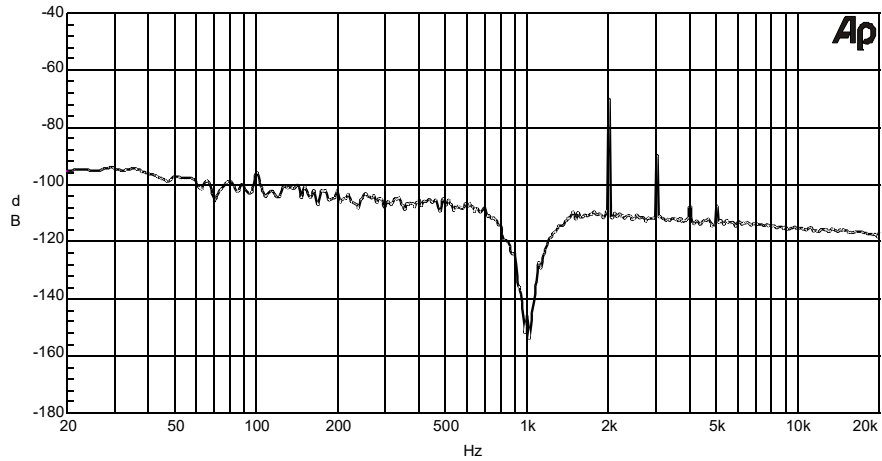

Noise spectrum at 1 kHz / 5 W into 4 ohms – there is no mains-generated interference to be seen. (50, 100 Hz) The k2, k3, k4 and k5 noise spectrum is extremely low and falls quickly.

15. FREQUENTLY ASKED QUESTIONS (FAQ)

1. Can you operate the V 80 SE when no loudspeakers are connected?

Yes. The V 80 SE, like all OCTAVE amplifiers, is fully protected against open circuit operation, i.e. the amplifier will come to no harm if it is operated without loudspeakers connected.

2. How do you recognize a faulty tube?

There are 3 different symptoms indicating a faulty tube:

1. A broken heater filament: the tube stops glowing
2. A defective cathode layer: the tube glows, but no current can flow. You can confirm this fault using the bias display LEDs – no matter how much you try to adjust the bias, the minus LED will always stay on.
3. A short circuit inside the tube. Normally, this will cause the electronic protection to cut in and the red "off" LED to illuminate, or else the tube will refuse to respond to bias adjustment (the display keeps returning to the red area).

The amplifier will still operate with either of these faults present, but the channel containing the faulty tube will be quieter than normal. The fault may not be obvious at low listening levels but distortion will become evident at higher listening levels.

If fault 3 occurs, the protection circuits will normally switch the amplifier off. You may also hear loud background noises just before it switches off, although these will not harm the amplifier (see chapter 13.2.2).

3. Is there a loss of sound quality as tubes age?

No. Tubes normally sound the same throughout their service life. Our soft-start technology contributes greatly to extending the service life of tubes. You can tell when an output tube has reached the end of its useful life: it becomes impossible to adjust it correctly. Driver tubes cannot be checked, but these will generally last for well over 10 years.

4. Does the V 80 SE have to have all of its tubes fitted?

In principle, the V 80 SE will also operate without tubes. It is sometimes useful to do this when testing the operation of the switching functions such as the selector switch, remote control, etc. Of course, it is not possible to play music under these circumstances.

For test purposes or as a temporary measurement of one channel may be fitted with just a single power tube, although its power output will, of course, be reduced. The amplifier will come to no harm if it is operated continuously like this.

Operation without driver tubes is also possible for test purposes, although, for obvious reasons, music playback is not possible.

5. What is the significance of loudspeaker impedance and efficiency?

The impedance and efficiency of modern loudspeakers is not an issue for OCTAVE amplifiers. The often-quoted damping factor is not normally a guarantee that an amplifier will exert tight control over the loudspeakers. In practice, speakers of 85 dB efficiency and above are suitable for use with tube amplifiers. The high stability of the OCTAVE power amplifier technology even allows the use of speakers whose impedance dips as low as 2 ohms.

6. What cables are suitable for tube power amplifiers?

The cable manufacturers are now offering cables that have supposedly been designed specifically for tube amplifiers. Although such cables may be of good quality, there is no need to use special cables with tube amplifiers. Speaker cable can exhibit high values of capacitance and inductance, and tube power amplifiers deal with such loads better than transistor power amplifiers. The only exception would be if you needed to use a tube pre-to-power amp interconnect cable longer than 5 meters. In that case, a low capacitance cable would be advisable.



We reserve the right to alter and improve the specifications in pursuit of better. OCTAVE logo is a registered trade mark of Andreas Hofmann. Copyright by Andreas Hofmann

OCTAVEAUDIO T. +49 (0) 7248 3278
ANDREAS HOFMANN F. +49 (0) 7248 3279
REUTAECCKERSTR. 5 INFO@OCTAVE.DE
DE-76307 KARLSBAD WWW.OCTAVE.DE